

OWAC

ENGINEERING COMPANY

think green_act circular



PORTFOLIO

REV 10.2023

ENG

OWAC, acronym for Open Water Company, is an engineering company that operates within the **ENVIRONMENTAL** sector developing circular economy initiatives that have true impact on people's lives and the Planet

We are a leading engineering company specialised in waste treatment and **WASTE TO ENERGY**, environmental remediation, water treatment and renewable energy

Our services cover all project phases and its entire lifecycle

We use **BIM METHODOLOGY** and advanced monitoring systems to reduce risks and costs while securing quality control and compliance with regulatory and legal requirements.

*"DEL CARATTERE DEGLI ABITANTI D'ANDRIA
MERITANO DI ESSERE RICORDATE
DUE VIRTÙ*

**LA SICUREZZA IN SÉ STESSI
E LA PRUDENZA.**

CONVINTI CHE

*OGNI INNOVAZIONE NELLA CITTÀ
INFLUISCA SUL DISEGNO DEL CIELO
PRIMA D'OGNI DECISIONE*

**CALCOLANO I RISCHI E I VANTAGGI
PER LORO E PER**

L'INSIEME DELLE CITTÀ E DEI MONDI"

ITALO CALVINO, LE CITTÀ INVISIBILI



UNI EN ISO 9001:2015 N. 30233/14/S
UNI EN ISO 45001:2018 N. OHS-4849
UNI EN ISO 14001:2015 N. EMS-9477/S
UNI/PDR 74:2019 N. SGBIM-0123



UNI/Pdr 74:2019 21042e

COMBUSTION SYSTEM, STEAM BOILER, FUEL GAS TREATMENT FOR **RDF PLANT** SERBIA

The Refuse Derived Fuel (RDF) plant counts with a Combustion Technology including grate and boiler, the Flue Gas treatment plant according to EU regulations, and the Combustion Control System (CCS). The components shall be installed at the existing site of a Coal Fired Power plant with an existing water - steam cycle.

The plant is designed with two combustion lines. Each line can incinerate 24.0 Mg/h RDF. The designed maximum gross heat release (heat input) of each combustion line is 106.1 MW.

- **Combustion Technology:** The reverse acting grate can keep the residence time of the fuel on the grate constant even during intensive agitations of the waste. The agitation velocity can be adjusted separately in each combustion zone. This guarantees stable results of the combustion and an optimal burn-out rate of the fuel if the fuel quality varies. The system is proven in many WtE plants world wide. The boiler is designed considering the specific requirements applying to RDF boilers. The amply dimension fumace brings about low fuel gas velocities, ensuring a high flue gas residence time.
- **Fuel Gas treatment:** To keep the emissions standard and the effective precipitation of pollutants (NOx, HCl, HF, volatile heavy metals and ashes) a semi dry process will be used.
- **Combustion Control System:** CCS allows continuous operations staying below established emissions limits.

LONGITUDINAL SECTION OF A TYPICAL WTE PLANT

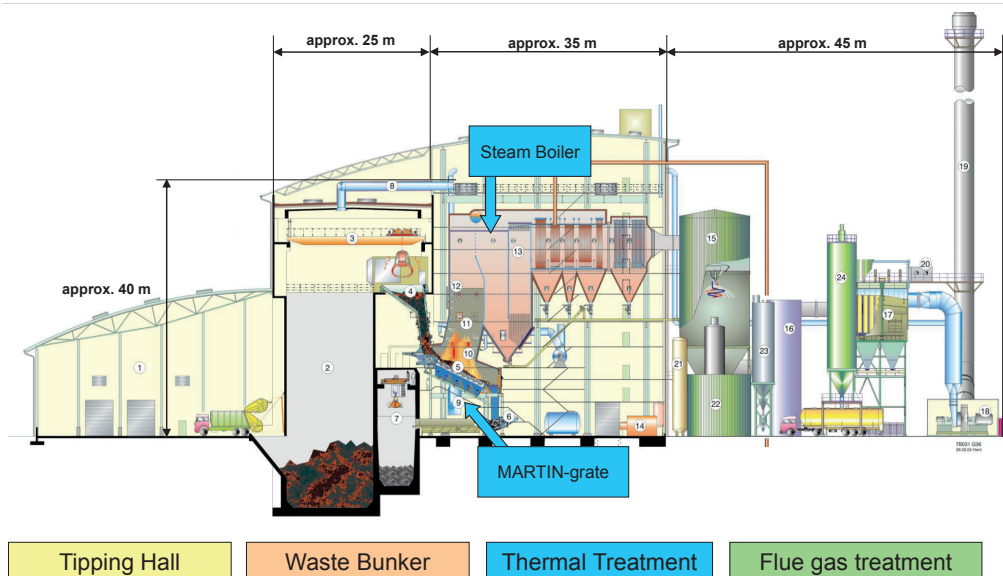

DESIGN DATA

Location Serbia
Site area 20.000 m³
Public client A.R. s.r.l.
Design period 2019
Cost 200.000.000,00 €

TECHNICAL DATA

2 combustion lines 24.0 mg/h of RDF
Heating value range (lhw) 11,00 - 18,00 kj/kg

PRELIMINARY STUDY FOR AN INTEGRATED SYSTEM OF **M.S.W. MANAGEMENT AND TREATMENT** IN TUNISIA

Upon request of the Ministry of Environment of Tunisia a preliminary study for the development of four Waste-to-Energy platforms has been produced to support the local Waste Management authorities.

Sources indicate that Tunisia produces more than 6 million tons of waste every year, with a trend of increasing volume of about 3% / year and a production of waste in urban areas of about 0.8 / 1.2 kg per day. Furthermore, there is a serious problem related to the waste already produced and stored in different areas of the country.

Currently it is found that the biodegradable organic component of waste represents 68% of the total volume, 80% is collected in urban areas and 10% in rural areas.

The integrated platforms designed by OWAC will strengthen the sustainable management of Municipal Solid Waste (MSW), carrying substantial improvements to the actual treatment processes.

The final goal of adequate Waste-to-Energy treatment plants is the prevention of negative environmental impacts as CO₂ emissions and promotion of circular economy programs, according to the principles of “economic, social and environmental sustainability”. The integrated MSW management platforms follows international recognized guidelines, such as:

- Environmental prevention
- Reuse of materials
- Recycling and other types of recovery
- Energy production (Electricity, Biogas, Thermal)
- Compost production for agriculture
- Disposal of residual waste to well constructed and monitored Landfills with leachate capture.

DESIGN DATA

Public client Ministry of the Environment of the Tunisian Republic

Type of service Preliminary Study

Cost 435 MLN €

Location Tunisia

Site area 25 ha

Number of person month for the assignment 6

Assignment duration 3 months

TECHNICAL DATA

- **Mechanical treatment plant with manual selection** recyclable material separation
Treatment capacity 3.500 t/year (1.300.000 t/year)
- **Biological treatment plant** stabilization of organic waste
Treatment capacity 160.000 t/year
- **Thermic plant** energy production
Treatment capacity 70 t/hour
- **Landfill** disposal of treatment residues
Available volume 3.000.000 m³
Guaranteed energy 640 GWh/year
- Installed power** 67 MW
- Estimated compost production** 50.000 t/year
- Biomethan production from wet fraction** 3.200.000 Stmc/year

NUMBER OF HABITANTS FOR GOVERNMENT

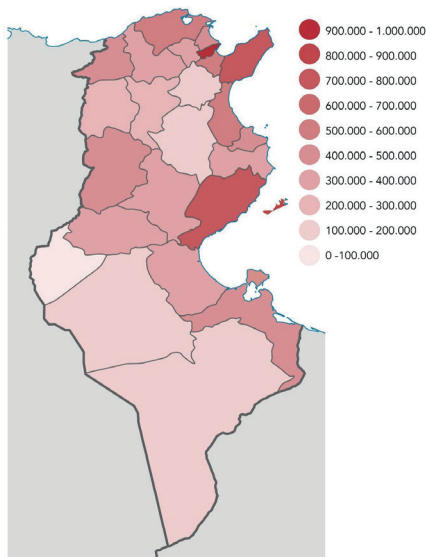

EXAMPLE OF WASTE TO ENERGY FACILITY PLANT



PRELIMINARY STUDY FOR DEV BOSSEA PROJECT IN SENEGAL

The DEV BOSSEA program in Senegal is part of the “social finance” initiatives focused on the use of economic and financial resources capable of improving the “real economy” of underdeveloped countries and thus promoting virtuous ways of growth and social innovation. For this purpose a BOOT contract has been signed between GIG BOSSEA and the Financial Institution IBE INC US, in which OWAC is involved for the development of two main phases, WP_01; CONSTRUCTION, UTILITIES, SOCIAL, SERVICES AND SPORT, and WP_02; ENERGY, PRIMARY INFRASTRUCTURE, WASTE MANAGEMENT. OWAC has prepared a Preliminary Study (PS) with the key considerations and guiding principles of the project.

The amount and complexity of the work required is often underestimated by countries during the transformation process to circular economy development programs. With this in mind, a realistic path in terms of costs, technical resources, timeframe for implementation, the required institutional and legal changes, and the potential for community participation has been established. A great amount of data was collected and studied for planning purposes and for determining the investment to be made and the infrastructure to be built.

With reference to the Work Plan 01 The project foresees the construction of n. 4.730 housing units for around 18-20,000 inhabitants. The Work Plan 02, related to the production of clean energy from renewable sources and the infrastructures for waste treatment, has been assessed, not only in compliance with the number of housing units, but in order to have enough capacity to serve nearby municipalities. The main focus of this feasibility study covers legal, institutional, financial and operational considerations, addressed to guarantee project sustainability and enhancing circular economy systems gradually, without outstanding interventions.

The main information described during project appraisal and PS are:

- (a) A description of the investment and its location.
- (b) The total cost and total eligible cost.
- (c) PS carried out, including options analysis, and the results.
- (d) A CBA, including an economic and a financial analysis.
- (e) An analysis of the environmental impact, taking into account climate change mitigation.
- (f) An explanation as to how the major project is consistent with the relevant priority axes of the operational program and the expected contribution to socio-economic development.
- (g) The timetable for implementing the project

■ Lac Rose ■ Bambilor ■ Diamniadio

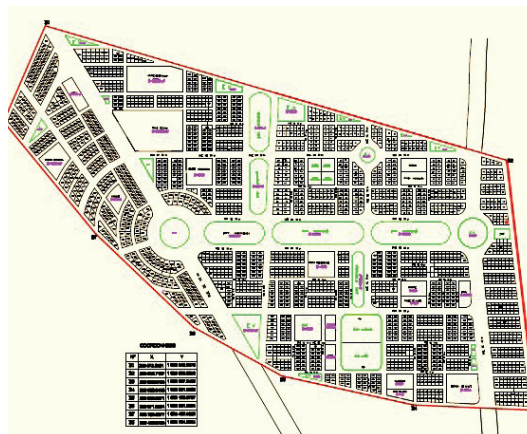

DESIGN DATA

Public client Ministry of the Environment of the Senegal Republic
Type of service Preliminary Study
Cost \$ 530,000,000.00
Location Senegal
Location within country Region de Matan
Assignment duration 6 months
Number of person month for the assignment 12
Expected projects implementations period
WP01 March 2020 - June 2024
WP02 June 2020 - February 2026

TECHNICAL DATA

WP01

- Work package description
 Construction of buildings for residential buildings with attached services shopping centre, sports facilities, social gathering areas, craft workshops, training rooms, conference rooms. The project foresees the construction, of n. 4.730 housing. The indicated cost also includes the construction of the water infrastructure, the sewerage system, public lighting.

WP02

- Work package description
ENER-01 Energy production from renewable sources (photovoltaic park, solar concentration plant).
ENER-02 Design and construction of no. 3 sludge water treatment plants for the production of natural fertilizers for agriculture and for the production of biomethane
ENER-03 Design and construction of no. 3 central production biomethane
ENER-04 Waste recycling system: steel (5%) and not ferrous metals (5%); energy production from Thermal Waste Oxidation of residual waste

PRELIMINARY DESIGN FOR PILOT WASTE TO ENERGY FACILITY HUBEI PROVINCE

This Pilot Project was developed for the Public Administration of the Province of Hubei (China). It has been designed so that it could be replicated in nearby locations.

It includes:

The Mechanical Pre Treatment Facility

The process has the purpose of maximizing the recovery of materials from the mass of undifferentiated waste; The process consists in the pre-selection of MSW in order to obtain the following different fractions: - Plastic material for recycling (PE, PET and other potentially recoverable plastics as a function of market demand); - Iron and aluminum for recycling in foundry; - Poor quality organic material which is directed to bio stabilization plants- Material with high calorific value, principally composed by the driest fractions of waste.

Biological Treatment facility

1.Aerobic: Aerobic Biological treatment for the organic fraction of MSW. The volume and in weight of waste as well as GHG emission and leachate will be effectively reduced. After approximately 21 day waste is ready to be sent to Landfill.

2.Anaerobic: With the Anaerobic Digestion the organic fraction of MSW will be processed in the absence of oxygen, in order to recover biogas. An upgrading process will then uptain biomethane that can be used and reinserted in the local economy.

Thermal Treatment for the Gasification Unit.

Biomass gasification allows the conversion of different biomass feedstocks to a more convenient gaseous fuel that can then be used for the generation of heat and electricity. Biomass gasification is a mature technology pathway that uses a controlled process involving heat, steam, and oxygen to convert biomass to hydrogen and other products, without combustion, and represents an efficient process for the production of chemicals and hydrogen.

EXAMPLE OF A PLANT TYPE



DESIGN DATA

Public client World Grand Inc.
Hong Kong
Type of service Preliminary
Design
Cost 6 MLN €
Location China - Hubei Province
Site area 2.0 ha

TECHNICAL DATA

Mechanical pre - treatments

- Primary shredder
- Sorting rotating drum
- Metal separator
- Aeraulic classifier
- Secondary (fine) shredder

Biological treatments

- Anaerobic digester
- Aerobic biocontainers

Thermal treatment

- Gasification unit
- Treatment capacity** 8000 t/
year

PRELIMINARY DESIGN FOR WASTE TO ENERGY FACILITY HUBEI PROVINCE

This technical Waste Management preliminary study is developed for three Municipalities of the Hubei Province located within the Central China region. The facilities proposed would mitigate negative environmental impact of mismanaged waste and promote waste prevention, reuse, recycle and recovery over waste disposal. This close interest from Chinese Administrators confirms their efforts to shift from disposal to reduction, treatment and recycling in order to achieve a circular economy concept using products in the most efficient way possible.

The technical proposal, that consists of 10 facilities for Xiangyang and Jingzhou cities which together count with over 11 Million inhabitants, and a total of 8 facilities, for Jingmen city that counts with 3 Million inhabitants, should be sided by adequate legal, regulatory and economic instruments, as well as firmly established Waste Management Strategic plan for the collection and transportation of waste. This will lead to a steady upgrading of the Waste Management sector in the Country that could be similarly replicated in other Chinese locations.

For Xiangyang and Jingzhou cities the study contemplates:

- Mechanical plants: about 6 hectares of land needed;
- Biological plants: about 7 hectares of land needed;
- Thermal plant: about 4 hectares of land needed;
- Landfills: about 20 hectares of land needed.

For Jingmen city the study contemplates:

- Mechanical plants: about 3 hectares of land needed;
- Biological plants: about 4.5 hectares of land needed;
- Thermal plant: about 2.5 hectares of land needed;
- Landfills: about 12 hectares of land needed.

LOCATION

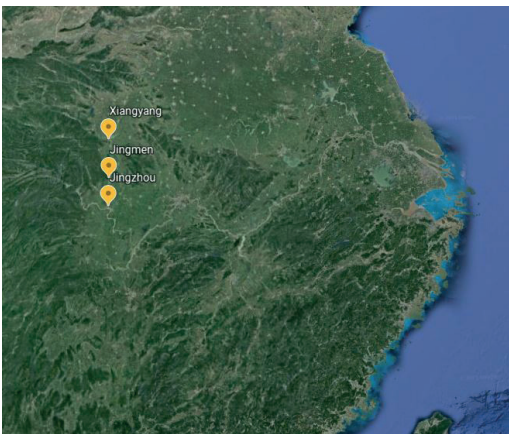

EXAMPLE OF A PLANT TYPE



DESIGN DATA

Location Xiangyang, Jingmen, Jingzhou cities
Public client World Grand Inc. Hong Kong
Type of service Preliminary Design
Site area Xiangyang and Jingzhou cities 37 ha
Site area Jingmen city 22 ha
Cost Xiangyang and Jingzhou cities 730 MLN €
Cost Jingmen city 435 MLN €

TECHNICAL DATA

XIANGYANG AND JINZHOU CITIES SOLUTION

A facility which can process about 2.300.000 t/year waste (mixed municipal solid waste), which is equal to 6.500 t/day approximately

- **Mechanical sorting plant** recyclable material separation
Treatment capacity 3.000 t/day (1.000.000 t/year)
- **Biological treatment plant** stabilization of organic waste
Treatment capacity 250.000 t/year
- **Thermal plant** energy production
Treatment capacity 130 t/hour
- **Landfill** disposal of treatment residues
Available volume 1.000.000 m³
Energy production 560 GWh/year
Installed power 80 MW

JINGMEN CITY SOLUTION

A facility which can process about 1.300.000 t/year waste (mixed municipal solid waste), which is equal to 3.500 t/day approximately

- **Mechanical sorting plant** recyclable material separation
Treatment capacity 3.500 t/day (1.300.000 t/year)
- **Biological treatment plant** stabilization of organic waste
Treatment capacity 160.000 t/year
- **Thermal plant** energy production
Treatment capacity 70 t/hour
- **Landfill** disposal of treatment residues
Available volume 1.000.000 m³
Energy production 560 GWh/year
Installed power 80 MW

PRELIMINARY DESIGN FOR **WASTE TO ENERGY** FACILITY HEBEI PROVINCE

This technical Waste Management preliminary study is developed for Chengde – Yudaokou Municipality which is part of the Hebei Province located within the North China region. The facilities proposed would mitigate negative environmental impact of mismanaged waste and promote waste prevention, reuse, recycle and recovery over waste disposal. Developing and implementing this kind of waste management systems requires comprehensive data on present and anticipated waste situations, supportive policy frameworks, knowledge and capacity to develop plans/systems, proper use of environmentally sound technologies, and appropriate financial instruments to support implementation.

The technical proposal consists of 5 facilities which include a Processing plant, a Mechanical pre-treatment plant, a Biological treatment plant, a Thermal plant and a Landfill. All of which will occupy approximately 15 hectares of land. The plants will recover plastics, glass, paper and metals that may be remanufactured creating a new market and sustainable economy. Around 40 GWh/year of electricity could be recovered to serve 40 000 users. Biogas will be extracted from Landfill and Anaerobic Digestion Plants generating Biofuels and lowering GHG emissions that will contribute to climate change tackling.

DESIGN DATA

Location Chengde - Yudaokou Township
Public client World Grand Inc. Hong Kong
Type of service Preliminary Design
Site area 25 ha
Cost: 148 MLN €

TECHNICAL DATA

Facility which can process about 250.000 t/year waste (mixed municipal solid waste), which is equal to 700 t/day approximately

- **Mechanical sorting plant** recyclable material separation
Treatment capacity 700 t/day (250.000 t/year)
- **Biological treatment plant** stabilization of organic waste
Treatment capacity 130.000 t/year
- **Thermic plant** energy production
Treatment capacity 12 t/hour
- **Landfills** disposal of treatment residues
Available volume 700.000 m³
Energy production 40 GWh/year
Installed power 10 MW

LOCATION

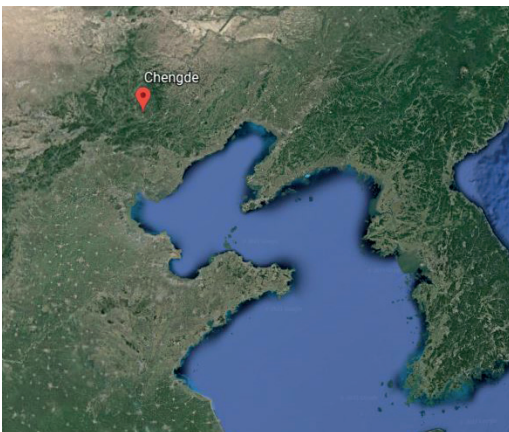

EXAMPLE OF A PLANT TYPE



PRELIMINARY DESIGN FOR A MECHANICAL AND BIOLOGICAL TREATMENT FACILITY FOR **MUNICIPAL SOLID WASTE TREATMENT** WITH ENERGY PRODUCTION IN INDONESIA

The plant lay-out provides one mechanical treatment line for the screening of M.S.W. with a capacity of 31.4 t/h. The process-line layout is the following: a wide area for the storage of the incoming waste, a shredding and a double-stage screening aimed to separate the following materials:

- i) oversize fraction, by which nonferrous metals (e.g. aluminium cans) and ferrous materials will be separated;
- ii) middlesize fraction, by which ferrous materials will be separated;
- iii) underscreen fraction, which is processed with biological treatment.

The designed layout also provides a fine shredding section for producing RFD from high calorific fractions.

Provided biological treatments for the underscreen fractions are:

- 1) anaerobic digestion to obtain biogas which can be recovered into a cogenerator engine for the production of electricity and thermal energy (supplied for the self-consumption of the plant);
- 2) aerobic stabilization of the digested sludge to obtain a stable dry material which can be recycled (compost).

The buildings will be kept in constant depression in order to ensure the health of workers; the air is recirculated within the aerobic tunnels to facilitate the biological process.

Lastly, the exhaust air will be treated with a scrubber and a biofilter, and so treated air can be given off into the atmosphere, since pollutant concentrations are reduced to the levels set forth by law.

DESIGN DATA

Location Indonesia
Site area 35.000 m²
Shed surface 12.000 m²
Design period 2015
Task assigned and carried out
Preliminary design
Cost € 3.500.000,00

TECHNICAL DATA

Operations according to Encl. B and C referring to Part IV of Law Decree No. 152/06 (D.Lgs. 152/06) and further amendments D8, D9, D14, D15, R1, R3, R4, R5, R13

Maximum capacity 50.000 t/year

TREATMENT

Mechanical pretreatment
shredding - double screening - ferrous and nonferrous metals recovery - RDF fine shredding
Biological treatment anaerobic digestion of underscreen materials (five closed tunnels) - biological stabilization and drying of the digested sludge (five closed tunnels)

RENDER VIEW



RENDER VIEW



PRELIMINARY DESIGN FOR A MECHANICAL, BIOLOGICAL AND THERMAL WASTE TREATMENT FACILITY IN FRENCH POLINESIA

The plant lay-out provides one mechanical treatment line for the screening of M.S.W. as follows: a wide area for the storage of the incoming waste, a shredding and a double-stage screening aimed to separate the following materials:

- i) oversize fraction, by which nonferrous metals (e.g. aluminium cans) and ferrous materials will be separated;
- ii) middlesize fraction, by which ferrous materials will be separated;
- iii) underscreen fraction, which is processed with biological treatment.

The designed layout also provides a fine shredding section for producing RFD from high calorific fractions.

Provided biological treatments for the underscreen fractions are:

- 1) anaerobic digestion to obtain biogas which can be recovered into a cogenerator engine for the production of electricity and thermal energy (supplied for the self-consumption of the plant);
- 2) aerobic stabilization of the digested sludge to obtain a stable dry material which can be recycled (compost).

The thermal treatment unit, using high efficiency turbines, allows to maximize energy recovery from waste (total power of 4-5 MW).

The buildings will be kept in constant depression in order to ensure the health of workers; the air is recirculated within the aerobic tunnels to facilitate the biological process.

Lastly, the exhaust air will be treated with a scrubber and a biofilter, and so treated air can be given off into the atmosphere, since pollutant concentrations are reduced to the levels set forth by law.

DESIGN DATA

Location French Polynesia
Site area 40.000 m²
Shed surface 17.000 m²
Design period 2015
Task assigned and carried out Preliminary design
Cost € 30.000.000,00

TECHNICAL DATA

Operations according to Encl. B and C referring to Part IV of Law Decree No. 152/06 (D.Lgs. 152/06) and further amendments D8, D9, D14, D15, R1, R3, R4, R5, R13
Maximum capacity 75.000 t/year
Treatment Mechanical
Pretreatment shredding - double screening - ferrous and nonferrous metals recovery - RDF fine shredding
Biological treatment anaerobic digestion of underscreen materials (seven closed tunnels) - biological stabilization and drying of the digested sludge (seven closed tunnels)
Thermal treatment Gasification

RENDER VIEW



RENDER VIEW



PRELIMINARY DESIGN FOR A MECHANICAL AND BIOLOGICAL TREATMENT FACILITY FOR MUNICIPAL SOLID WAST IN POLAND

The plant lay-out provides two mechanical treatment lines for the screening of M.S.W. as follows: a wide area for the storage of the incoming waste, shredding and double-stage screening aimed to separate the following materials:

- i) oversize fraction, by which nonferrous metals (e.g. aluminium cans) and ferrous materials will be separated;
- ii) middlesize fraction, by which ferrous materials will be separated;
- iii) underscreen fraction, which is processed with biological treatment. The designed layout also provides recyclable and high calorific plastics recovery.

Provided biological treatment for the underscreen fractions is aerobic stabilization in static windrows, covered with breathable fabrics. A significant aspect is related to the reduction of emissions into the atmosphere: odorous substances are retained within the windrows. During the oxidation process, the temperature increases due to the degradation activity of the microorganisms, and the evaporation of interstitial water forms a thin film in contact with the cloth itself. Such thin film, together with the small weaving of the cloth (0.2 µm), constitutes a mechanical barrier against the odorous molecules. Smaller molecules (O₂, CO₂, water vapor), instead, are free to transpire. This prevents approximately 95% of the spores and pathogenic bacteria to be spread in the air.

The buildings will be kept in constant depression in order to ensure the health of workers; the air is recirculated within the aerobic tunnels to facilitate the biological process.

Lastly, the exhaust air will be treated with a scrubber and a biofilter, and so treated air can be given off into the atmosphere, since pollutant concentrations are reduced to the levels set forth by law.

DESIGN DATA

Location Czestochova - Poland
Site area 50.000 m²
Shed surface 10.000 m²
Design period 2014
Task assigned and carried out preliminary design
Cost € 12.000.000,00

TECHNICAL DATA

Operations according to Encl. B and C referring to Part IV of Law Decree No. 152/06 (D.Lgs. 152/06) and further amendments D8, D9, D14, D15, R3, R4, R5, R13
Maximum capacity 250.000 t/year
Treatment Mechanical
Pretreatment shredding - double screening - ferrous and nonferrous metals recovery - plastics recovery
Biological treatment: biological stabilization (sixteen aerated windrows)

EXAMPLE OF A PLANT TYPE



EXAMPLE OF A PLANT TYPE



PRELIMINARY DESIGN FOR AN **AEROBIC BIOSTABILIZATION** FACILITY FOR ORGANIC WASTE IN POLAND

The plant operates a biological treatment for stabilizing the organic fraction from MSW. The process of biostabilization occurs within 12 concrete lanes; their bottom is provided with a system for the insufflation of the air that is necessary for the process. The air is uniformly distributed through parallel channels, which extend to the entire length of each composting lane. During the process, temperature, humidity and interstitial oxygen are monitored, and air insufflation is modulated on the basis of these measured parameters.

The buildings will be kept in constant depression in order to ensure the health of workers; the air is recirculated within the aerobic tunnels to facilitate the biological process. Lastly, the exhaust air will be treated with a scrubber and a biofilter, and so treated air can be given off into the atmosphere, since pollutant concentrations are reduced to the levels set forth by law.

DESIGN DATA

Location Czestochova - Poland
Site area 15,000 m²
Shed surface 4.600 m²
Design period 2013
Task assigned and carried out preliminary design
Cost € 5.000.000,00

EXAMPLE OF A PLANT TYPE



EXAMPLE OF A PLANT TYPE



TECHNICAL DATA

Operations according to Encl. B and C referring to Part IV of Law Decree No. 152/06 (D.Lgs. 152/06) and further amendments R3, R4, R12, R13
Maximum capacity 30.000 t/year
Treatment aerobic biostabilization (twelve aerated dynamic lanes)



COMBINED MULTIFUNCIONAL INDUSTRIAL PLANT FOR SLUDGE AND LIQUID WASTE TREATMENT - FOGGIA

The proposed project features a multi-combined platform divided in **two distinct sections**:

1. A sludge treatment section with capacity for 50.000 t/year for sludge collected in the Province of Foggia.
2. A Waste Water Treatment Plant (WWTP) for liquid civil waste with a total capacity of 300 m³/day

The project promotes **circular economy practices** through the recovery of energy available within the sludge matter and transforms the energy to biogas and biomethane. For this purpose, cutting-edge anaerobic digestion technologies are used.

The platform has the following purposes:

- the **production of biogas** using the anaerobic digestion section to process the incoming sludge;
- the **upgrade** of biogas to biomethane;
- the **dewatering** of residual waste from the anaerobic digestion that can later be briquetted and used in construction or disposed in sanitary landfills;
- the production of **lignite** through innovative processes;
- the production of **purified water** to be used for irrigation purposes.

As summarized below, the design choices find an optimal equilibrium between the different treatment and recovery techniques:

A. SLUDGE TREATMENT SECTION

B. WWTP:

The average quantity of clarified permeate will be approximately 156 m³ /day . The chemical composition complies with the limits specified on table 4, annex 5, part three of the Legislative Decree 152/06 and subsequent amendments, as well as adhering to the requirements concerning reuse of waste water reported on the Ministerial Decree 12 June 2003, n. 185.

DESIGN DATA

Public client Acquedotto Pugliese S.p.A
Type of service Technical and economical feasibility study
Project cost € 30.222.924,45
Location Foggia
Total site surface 51.000 m²
Design period June 2022

TECHNICAL DATA

SLUDGE TREATMENT SECTION

Treatment capacity: 50.000 t/year
Anaerobic reactors: 2 digestors (wet) of 3.100 m³ each
Biogas producible: 3.800.000 Nm³/year
Cogenerator:
 Eletric power 1.200 kW
 Termical power 1.239 kW

WWTP

Treatment capacity: 300 m³/day
Clarified water produced: 156 m³/day
Concentrate produced: 12 m³/day





REVAMPING OF THE MUNICIPAL SOLID WASTE TREATMENT PLANT - TUFINO

Making the most of the EU Recovery and Resilience Facility (RRF) instrument, the project provides an upgrade to the plant layout in order for it to meet the increasingly stringent environmental regulations and maximize recovery and recycling rates. The initiative broadly contributes to enhancing the integrated cycle of urban waste.

The plant produces biomethane for the transport sector and compost for agricultural use in compliance with European and national regulations (EU regulation EN:13432 and the new European fertilizer regulation 2019/1009).

The revamp will include two process lines:

- An Aerobic-Anaerobic treatment section for the Organic Fraction of the Municipal Solid Waste (OFMSW) that will recover high-quality compost and biomethane;
- A Section for the recovery of paper and cardboard coming from MSW segregated at source.

The aerobic-anaerobic process line provides a waste treatment capacity equal to 75.500 t/year, 57.000 t/y of OFMSW, and 18.700 t/y of green waste. The section consists of:

- a) A reception bunker followed by mechanical pre-treatment of incoming waste;
- b) An anaerobic digestion section, where biomass undergoes a biochemical conversion producing biogas and a residual liquid (digestate);
- c) A digestate mechanical dewatering section, with subsequent flocculation and flotation treatment followed by a leachate treatment plant;
- d) A composting section for the aerobic stabilization of the solid digestate, thus obtaining a quality compost;
- e) An up-grading unit for the biogas produced by the anaerobic digestion to bio-methane.

Cutting-edge technologies that will be implemented in the paper and cardboard sorting line will allow a recovery capacity of 37.200 t/year.

Last but not least, an exhausted air treatment system (scrubber, biofilter, and bag filters); will ensure gaseous-effluent compliance with EU and local regulations.

DESIGN DATA

Public client A.T.O. NA 3
Type of service Technical and economic feasibility project
Project cost € 28.139.804,00
Location Tufino (NA)
Total site surface 88.000 m²
Design period December 2021

TECHNICAL DATA

AEROBIC-ANAEROBIC OFMSW SECTION

Treatment capacity: 75.700 t/year
Process duration: 90 days
Anaerobic reactors: 2 of 2.100 m³ each
In-vessel reactor for aerobic stabilization: 7 of 322 m³ each
Maturation phase: 9 turning piles of 576 m³ each
Produced Compost: 10.500 t/year
Produced Biomethane: 600 Sm³/h

PAPER AND CARDBOARD RECOVERY LINE

Treatment capacity: 37.200 t/year
Mechanical treatment: Double screening stage, optical separation, highly automated (robotic) sorting, pressing and filming
Plastic material bales: 2.400 t/year
Paper and Cardboard bales: 29.000 t/year





REVAMPING OF MUNICIPAL SOLID WASTE TREATMENT PLANT - GIUGLIANO

Making the most of the EU Recovery and Resilience Facility (RRF) instrument, the project provides an upgrade to the plant layout in order for it to meet the increasingly stringent environmental regulations and maximize recovery and recycling rates. The initiative broadly contributes to enhancing the integrated cycle of urban waste.

The plant produces biomethane for the transport sector and compost for agricultural use in compliance with European and national regulations (EU regulation EN:13432 and the new European fertilizer regulation 2019/1009).

The revamp will include three process lines:

- An aerobic-anaerobic treatment section for the Organic Fraction of the Municipal Solid Waste (OFMSW) that will recover high-quality compost and biomethane;
- A section for the recovery of paper and cardboard coming from municipal solid waste segregated at source.
- A section for the recovery of glass coming from municipal waste segregated at source (colour-sorted glass, cullet production).

The aerobic-anaerobic process line provides a waste treatment capacity equal to 57.000 t/y of OFMSW, and 18.700 t/y of green waste. The section consists of:

- a) A reception bunker followed by mechanical pre-treatment of incoming waste;
- b) An anaerobic digestion section, where biomass undergoes a biochemical conversion producing biogas and a residual liquid (digestate);
- c) A digestate mechanical dewatering section, with subsequent flocculation and flotation treatment followed by a leachate treatment plant;
- d) A composting section for the aerobic stabilization of the solid digestate, thus obtaining a quality compost;
- e) An up-grading unit of the biogas produced by anaerobic digestion to bio-methane production.

Cutting-edge technologies that will be implemented in paper / cardboard and glass sorting lines will allow a recovery capacity of 37.200 and 77.000 t/year respectively.

Last but not least, an exhausted air treatment system (scrubber, biofilter, and bag filters); will ensure gaseous-effluent compliance with EU and local regulations.



DESIGN DATA

Public client A.T.O. NA 2
Type of service Technical and economic feasibility design
Project cost € 36.825.466,06
Location Giugliano (NA)
Total site surface 60.000 m²
Design period December 2021

TECHNICAL DATA

AEROBIC-ANAEROBIC OFMSW SECTION

Treatment capacity: 75.700 t/year
Process duration: 90 days
Anaerobic reactors: 2 of 2.100 m³ each
In-vessel reactor for aerobic stabilization: 7 of 330 m³ each
Maturation phase: 9 turning piles of 492 m³ each
Produced Compost: 10.500 t/year
Produced Biomethane: 600 Sm³/h

PAPER AND CARDBOARD RECOVERY LINE

Treatment capacity: 37.200 t/year
Mechanical treatment: Double screening stage, optical separation, highly automated (robotic) sorting, pressing and filming
Plastic material bales: 2.400 t/anno
Paper and Cardboard bales: 29.000 t/year

GLASS RECOVERY LINE

Treatment capacity: 77.000 t/year
Mechanical treatments: aeraulic separation, manual sorting, crusher, magnetic separator, foucault current separator, binary and ternary optical separation
Green glass cullet: 26.250 t/year
Flint glass cullet: 26.250 t/year
Amber glass cullet: 13.130 t/year
High melting point glass: 6.663 t/year
Metals (ferrous and non-ferrous): 875 t/year



INDUSTRIAL PLANT WITH COMBINED ANAEROBIC/AEROBIC TREATMENT OF OFMSW FOR THE PRODUCTION OF BIOMETHANE AND COMPOST - LECCE

Making the most of the EU Recovery and Resilience Facility (RRF) instrument, the project is in line with the increasingly stringent environmental regulations and maximize recovery and recycling rates. The initiative broadly contributes to enhancing the integrated cycle of urban waste.

The plant produces biomethane for the transport sector and compost for agricultural use in compliance with European and national regulations (EU regulation EN:13432 and the new European fertilizer regulation 2019/1009).

The project will include two process lines:

- An aerobic-anaerobic treatment section for the Organic Fraction of the Municipal Solid Waste (OFMSW) that will recover high-quality compost and biomethane;
- A wastewater and leachate treatment section that will reduce sludge to be disposed and recover clarified water.

The aerobic-anaerobic process line provides a waste treatment capacity equal to 50.000 t/year, 40.000 t/y of OFMSW, and 10.000 t/y of green waste. The section consists of:

- a) A reception bunker followed by mechanical pre-treatment of incoming waste;
- b) An anaerobic digestion section, where biomass undergoes a biochemical conversion producing biogas and a residual liquid (digestate);
- c) A digestate mechanical dewatering section, with subsequent flocculation and flotation treatment followed by a leachate treatment plant;
- d) A composting section for the aerobic stabilization of the solid digestate, thus obtaining a quality compost;
- e) An up-grading unit of the biogas produced by anaerobic digestion for bio-methane production.

The wastewater and leachate are taken to the WWTP. The permeate/effluent will be suitable for on-site reuse (irrigation, processes need, etc) considerably reducing water consumption.

The WWTP will have a daily treatment capacity of 100 m³/day and includes a MBR (Membrane Bioreactor) treatment section for the oxidation of suspended biomass and the removal of ammonia nitrogen, followed by two units of ultrafiltration and reverse osmosis to ensure a high-quality output. The concentrate is sent to an evaporator for a further volumetric reduction and it will be shipped to duly authorized third-party plants.

Last but not least, an exhausted air treatment system (scrubber, biofilter, and bag filters); will ensure gaseous-effluent compliance with EU and local regulations.

DESIGN DATA

Public client Ager Puglia
Type of service Technical and economic feasibility design
Project cost € 35.286.729,56
Location Lecce (LE)
Total site surface 53.819 m²
Design period December 2021

TECHNICAL DATA

AEROBIC-ANAEROBIC OFMSW SECTION

Treatment capacity: 50.000 t/year
Process duration: 90 days
Anaerobic reactors: 1 of 3.200 m³ each
In-vessel reactor for aerobic stabilization: 7 of 412 m³ each
Maturation phase: 5 turning piles of 673 m³ each
Produced Compost: 7.200 t/year
Produced Biomethane: 410 Sm³/h





REVAMPING OF THE AEROBIC / ANAEROBIC INTEGRATED PLANT FOR THE **TREATMENT OF FORSU** – SALERNO

The project aims to improve the composting plant of the Municipality of Salerno, which has a treatment capacity of 30.000 t/year and is operated by Salerno Pulita S.p.A.

The production process is upgraded to use the BATs and incorporate industry 4.0, interconnectivity and smart automation solutions, such as advanced software, cloud, robotics, and remote monitoring.

Through the abovementioned interventions the existing anaerobic digestion of organic matter will achieve maximum production capacity of biogas, to be fed to the cogeneration process for the production of electricity and thermal energy.

For the revamping of the anaerobic treatment process the following activities are expected:

- Adaptation of the FORSU pre-treatment systems, mainly by replacing the existing press unit with a higher performance machine that integrates advance technological solutions;
- Decommissioning of existing emergency flare, now out-of-service, and installation of new open-flame flare with steady combustion temperature;
- Decommissioning of the existing gasometer system and installation of a new two membrane press static system
- Inertization with nitrogen, emptying and washing the digesters;
- Revamping of the anaerobic digestion system through replacing the vertical agitators, pumping systems and the polyelectrolyte dissolution system and reconditioning the piping and valves.
- Extraordinary maintenance of the existing biological desulfurization system and revamping of the biogas upgrading system by replacing the cogeneration units;
- Installation of an advanced monitoring system for the composting in-vessel reactors and for the anaerobic digestion process
- installation of continuous remote automation and monitoring system

The anaerobic digestion of the OFMSW, is expected to produce 683.421 Sm³/year of biogas. On the other hand, the composting process of the solid fraction, obtained from pressing the dehydrated digestate and blending it with lingo-cellulosic waste (green waste), will produce 10.140 t/year of compost.

DESIGN DATA

Public client Salerno Pulita
Type of service Definitive design
Project cost € 3.120.405,36
Location Salerno (SA)
Total site surface 46,109 m²
Design period October 2021

TECHNICAL DATA

AEROBIC-ANAEROBIC OFMSW SECTION

Treatment capacity: 30.000 t/year
Process duration: 90 days
Anaerobic reactors: 3 of 800 m³ each
In-vessel reactor for aerobic stabilization: 10 of 287 m³ each
Maturation phase: 6 turning piles of 356 m³ each
Produced Compost: 10.140 t/year
produced Biomethane: 80 Sm³/h.
Thermal energy produced: 1.000 MWh/anno

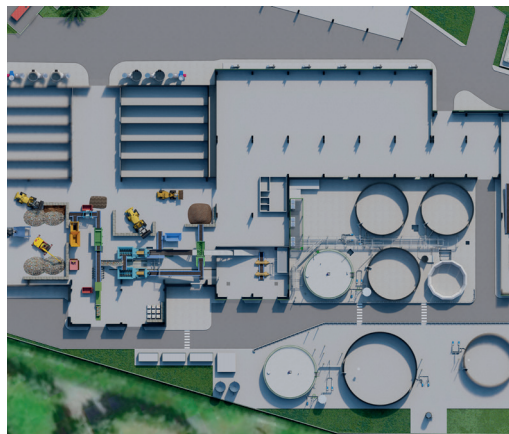



HIGHLY AUTOMATED PAPER AND CARDBOARD RECOVERY FACILITY - NAPOLI

In line with decree (108 of 23/02/2022) issued by the Campania Region, the initiative provides space optimization that adapts to the upcoming waste reception and final product storage.

A highly automated paper and cardboard recovery section is provided. The line counts with automatic screening and sorting as well as robotic quality control reaching a processing capacity of 37.200 tons/year.

The following objectives and performance levels are expected:

- Mitigation of social impacts related to transportation of waste to terminals outside the province or region;
- Best ratio between investment costs, operating costs and material recovery performance (paper and cardboard) in accordance with the BATs.
- Full compliance of the regional policy framework in line with the local urban waste management plan.
- Obtaining grants released by the National Recovery and Resilience Facility Plan (RRF), under measure M2C1.1.I1.1 - Line B;
- The mitigation of environmental impacts related to paper and cardboard recovery processes
- The achievement of circular economy goals related to waste and the fulfilment of EU standards concerning the conservation of natural environments, climate change and carbon footprint.

DESIGN DATA

Public client Comune di Napoli
Type of service Preliminary design
Project cost € 8.774.088,20
Location Naples (NA)
Total site surface 7.600 m²
Design period January 2022

TECHNICAL DATA

PAPER AND CARDBOARD RECOVERY LINE

Treatment capacity: 37.200 t/year
Mechanical treatment: Double screening stage, optical separation, highly automated (robotic) sorting, pressing and filming
Plastic material bales: 1.200 t/year PET and 1.200 t/year PE+PP
Paper bales: 21.200 t/year
Cardboard bales: 7.800 t/year

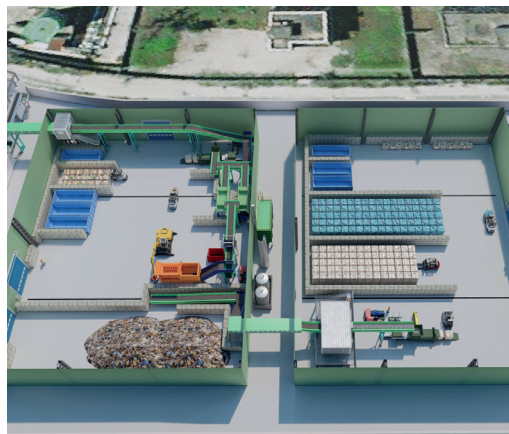



HIGHLY AUTOMATED MATERIAL RECOVERY FACILITY (MRF) FOR **PAPER, CARDBOARD AND GLASS** - CAIVANO

The project will take place within the ASI area and is developed by "S.A.P.NA." Sistema Ambiente Provincia di Napoli S.p.A. The Recovery and Resilience Facility (RRF) instruments is used to finance the project, meet the increasingly stringent environmental regulations and maximize recovery and recycling rates. The initiative broadly contributes to enhancing the integrated cycle of urban waste. Cutting-edge technologies and advanced control systems are used in compliance with EU and national regulations. Two highly automated process lines are provided:

- A section for the recovery of paper and cardboard coming from waste already segregated at source (differentiated collection).
- A section for the recovery of glass coming from waste already segregated at source (colour-sorted glass, cullet production)

The project aims to guarantee R3 - R5 - R13 waste management operations in line with national Decree 152/2006.

DESIGN DATA

Public client ATO NA 1 (public / private committee)
Type of service feasibility study
Project cost € 11.181.816,25
Location Caivano (NA)
Total site surface 70.000 m²
Design period February 2022

TECHNICAL DATA

PAPER AND CARDBOARD RECOVERY LINE

Treatment capacity: 37.200 t/year
Mechanical treatment: Double screening stage, optical separation, highly automated (robotic) sorting, pressing and filming
Recoverable materials: Plastic materials, Paper bales, Cardboard bales

GLASS RECOVERY LINE

Treatment capacity: 77.000 t/anno
Mechanical treatments: aeraulic separation, manual sorting, crusher, magnetic separator, foucault current separator, binary and ternary optical separation
Recoverable materials: Green glass cullet
 Flint glass cullet
 Amber glass cullet
 High melting point glass
 ferrous and non-ferrous metals





MULTIFUNCTIONAL WASTE TO ENERGY PLANT - CASTELLANA SICULA

In the context of circular economy and energy recycling, the municipal waste platform is planned in order to produce energy and secondary raw material from MSW.

Thanks to an anaerobic digestion section, the plant is expected to produce biomethane and compost from the OFMSW, and raw material from the residual fraction of MSW. Moreover, in the platform will be executed the pre-processing and the securing of the WEEE (Waste of electric and electronic equipment) and the pre-treatment of the bulky waste.

The plant has a maximum treatment capacity of 42.500 t/year for the OFMSW section and 68.000 t/year for the residual fraction of MSW, 300 t/year for the bulky waste and finally a capacity of 1.500 t/year for the e-Waste.

The Plant activities can be divided as follows:

A. OFMSW TREATMENT SECTION

- Mechanical pre-treatment
- Anaerobic digestion – Biogas production - Biomethane up-grading
- High quality compost production

B. MECHANICAL BIOLOGIC TREATMENT SECTION FOR RESIDUAL WASTE OF MSW, BULKY WASTE AND DRY FRACTION OF MSW

- mechanical separation treatment
- anaerobic stabilization – biogas production – Biomethane up-grading
- RDF production
- secondary raw material production (paper, plastic, metals, i.e.)
- separation and collection of recyclable material from bulky waste
- mechanical treatment and volume reduction, with final baling

C. PRE-PROCESSING AND SECURING OF E- WASTE

- e-Waste storage
- Disassembly and waste securing
- Stockage of dangerous and non-dangerous -compound

DESIGN DATA

Private client Biowaste CH4 Castellana Sicula S.r.l.
Type of service Definitive design
Project cost € 55.420.465,65
Location Castellana Sicula (PA)
Total area 80.000 m²
Design period 2021

TECHNICAL DATA

OFMSW TREATMENT SECTION

Capacity: 42.500 t/year
Process length: 90 days
Anaerobic digester: 1 of 2.250 m³
Bio-cells for aerobic stabilization: 8 of 510 m³ each
Maturation platform: 2 of 2.700 m³ each
Compost produced: 14.000 t/year
Biomethane produced: 280 Sm³/h
Recycled plastics produced: 3.900 t/year
Recycled metals produced: 300 t/year

MSW TREATMENT SECTION

Capacity: 60.000 t/year
Stabilization process length: 38 days
Bio-cells anaerobic: 9 of 350 m³ each
Biocell for aerobic stabilization: 5 of 350 m³ each
Post-treatments: shredding of the RDF and baling
Organic fraction stabilized: 14.600t/year
Recycled plastics produced: 6.300 t/year
Recycled metals produced: 1.100 t/year
Biomethane produced: 180 Sm³/h

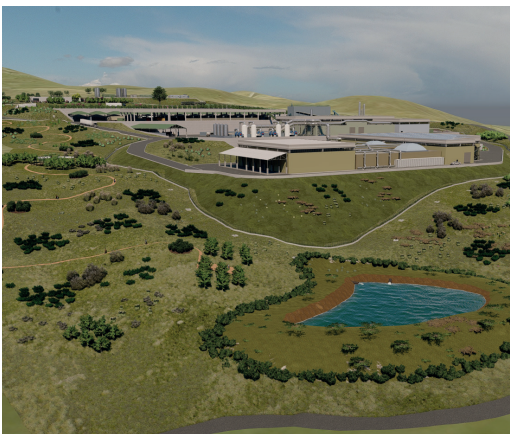



MULTIFUNCTIONAL **WASTE TO ENERGY** PLANT - MAZZARRA' SANT'ANDREA

The project arises from the demand to recover the Organic Fraction of the Municipal Solid Waste (OFMSW) resulting from source separated collection. A combination of innovative technologies is set to maximize biomethane production. It involves the construction and operation of a multi-combined platform with two major sections for the treatment and processing of non-hazardous MSW collected within the Messina Province. The platform is expected to receive:

- OFMSU resulting from separate waste collection;
- Green waste from pruning of parks and gardens;
- Undifferentiated MSW and/or undifferentiated (residual) MSW from separated collection.

The implementation of the project consists of:

1. Recovery of the existing facilities and its integration with the new ones enabling:
 - A section designated to treat undifferentiated MSW which includes the stabilization of the organic content, material recovery such as metals and plastics, the production of Refuse-Derived Fuel (RDF) and biogas.
 - A section designated to treat Organic Fraction of the Municipal Solid Waste (OFMSW) resulting from source separated collection which will produce high quality compost and biogas;
 - A section designated for the upgrading of biogas produced after anaerobic digestion. The outcome, biomethane, should be fed into the national grid. The green energy recovered from the abovementioned sections will substantially benefit decarbonisation and the economy.
2. The reactivation of the unused old landfill leachate treatment plant, integrating existing structures and equipment's with new required facilities. Both the leachate and wastewater produced from the MSW treatment industrial platform will be treated.

DESIGN DATA

Private client Asja Ambiente Italia S.p.A
Type of service Definitive design
Project cost € 44.252.200,29
Location Zuppa' - Mazzarra' Sant'Andrea (ME)
Total site surface 73.000 m²
Design period 2020

TECHNICAL DATA

Compost production:
14.000 t/year
Biostabilized organic fraction:
29.000 t/year
Secondary solid fuel:
49.200 t/year

OFMSW SECTION

Capacity: 60.000 t/year
Biogas production: 1.200 Sm³/h
Biomethane production: 710 Sm³/h
Exhaust air treatment capacity:
300.000 m³/h

MSW SECTION

Capacity: 100.000 t/year
Biogas production: 510 Sm³/h
Biomethane production: 245 Sm³/h
Exhaust air treatment section:
100.000 m³/h
Recovered materials:
 2.000 t/anno ferrous metal
 1.300 t/anno non-ferrous metal
 6.500 t/anno plastic
 6.900 t/anno chlorinated plastic





MULTIFUNCTIONAL **WASTE TO ENERGY** PLANT BELLOLAMPO - COMUNE DI PALERMO

The project foresees the revamping of an existing Mechanical Biological Treatment (MBT) plant, as well as the construction of a new section for the treatment and energy recovery of the Organic Fraction of the Municipal Solid Waste (OFMSW) resulting from source separated collection. Added-value products such as biomethane, biofertilizers, Refuse-Derived Fuel (RDF) will be produced as well as ferrous and non-ferrous metals recovered.

The project includes:

- Improvement of the organic fraction treatment resulting from the MBT; Improvement of the organic fraction treatment resulting from the MBT;
- Treatment facility for the OFMSW resulting from source separated collection;
- Biofertilizers and quality compost production from the OFMSW (resulting from source separated collection);
- Biomethane production from OFMSW and MSW.

The project integrates the existing facilities with the new industrial structures. The final layout includes:

- A pre-treatment section for the OFMSW resulting from source separated collection; two anaerobic digestors (AD) to process the organic fraction sourced from the MBT section and the inflow of OFMSW resulting from source separated collection;
- A section for the upgrading of biogas resulting from AD to obtain biomethane;
- A facility to feed biomethane into the natural gas grid;
- A bio stabilization section for the digestate generated from the AD of the OFMSW from undifferentiated collection and sewage sludge (existing);
- A bio stabilization for the digestate generated from the AD of the OFMSW resulting from source separated collection to produce high-quality compost.

As a result, two different waste treatments processes will be integrated:

- 1. OF-MBT process.** This will treat the undersized organic fraction material obtained though the existing mechanical pre-treatment facility.
- 2. OFMSW process.** This will treat the OFMSW from source separated collection.

The OF-MBT process scope is the treatment of the OF obtained from the existing MBT facility through a section of dry anaerobic digestion for the production of biogas that will be sent, together with the one obtained by the OFMSW, to the upgrading facility which will capture CO₂, and therefore, obtaining biomethane. Waste coming from AD will be subject to accelerated bio-oxidation at the existing biocells. From this process an inodore outcome with low humidity (less than 50%) is obtained and destined to landfill. The FORSU process aims to obtain through AD the production of biogas and fertilizer and/or quality compost. Again, the biogas, which will be upgraded, can be fed directly in the national grid.

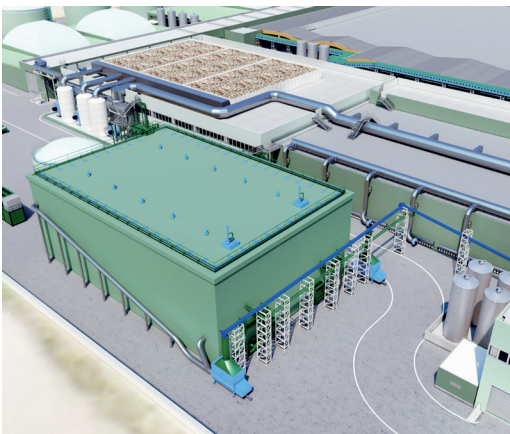

DESIGN DATA

Private client Biowaste CH4 Palermo S.r.l.
Type of service detailed design, executive project, construction supervision, commissioning and operation monitoring
Project cost €51.128.321,75
Location Palermo
Total site surface 40.000 m²
Design period June 2020

TECHNICAL DATA

OFMSW capacity: 60.000 t/year
OF-MBT capacity: 100.000 t/year
Exhaust air treatment capacity: 250.000 m³/h

OFMSW PROCESS

Compost production: 14.500 t year
Biogas production: 1.100 Sm³/h
Biomethane production: 638 Sm³/h

OF-MBT PROCESS

Biogas production: 1.230 Sm³/h
Biomethane production: 650 Sm³/h
Stabilized organic fraction production: 67.300 t/year



INTEGRATED PLATFORM FOR URBAN WASTE TREATMENT TO BE LOCATED IN BRINDISI

The urban waste platform is expected to produce biomethane and quality compost from the OFMSW and RDF and recycled materials from the residual fraction of MSW. The treatment and recycling platform is organized into two independent sections, ones for the OFMSW and the other one for the residual waste treatment.

The plant has a maximum treatment capacity of 54.000 t/year for the OFMSW section and 100.000 t/year for the residual fraction of MSW and the dry fractions of the separated collection.

The project aims to assure the waste management operations R3 - R4 - R5 - R13- D8 - D13 - D15 according to Legislative Decree 152/2006 (as indicated in Annex B and C of the fourth part).

The Plant activities can be divided as follows:

A. OFMSW TREATMENT SECTION

- reception and storage of the incoming waste
- mechanical pre-treatment
- anaerobic digestion
- digested post-treatment
- composting process
- biogas treatment and biomethane production

B. RESIDUAL WASTE TREATMENT AND RECOVERY SECTION

- reception and storage of the incoming waste
- aerobic stabilization into biocells
- screening and disposal of the stabilized undersize
- separation of the recyclable materials
- RDF refining and pressing

The biologic treatment of the OFMSW produces a high-quality compost equal to about 8.400 t/year and biomethane for about 390 Sm³/h.

From the treatment section of the residual waste fraction and the dry fractions of the separated collection, it is obtained a stabilized organic fraction (O.F) of about 32.900 t/year, a RDF equal to approximately 17.300 t/year, ferrous and non-ferrous recycled metals equal to 1.600 t/year and 750 t/year and recyclable plastics equal to approximately 11.500 t/year.



DESIGN DATA

Public client Ager Puglia
Type of service Definitive design
Project cost € 37.081.730,75
Location Brindisi
Tot area 69.601 m²
Design period May 2020

TECHNICAL DATA

OFMSW TREATMENT SECTION

Capacity: 46.700 t/year
Process length: 90 days
Anaerobic digester: 2 of 1.500 m³ each
Bio-cells for aerobic stabilization: 7 of 120 m³ each
Maturation platform: 6 of 444 m³ each
Compost produced: 8.400 t/year
Biomethane produced: 430 Sm³/h

MSW TREATMENT SECTION

Capacity: 44.300 t/year
Stabilization process length: 14 days
Bio-cells anaerobic: 10 of 530 m³ each
Post-treatments for undersize compound: induced currents separator (ED current) and iron separator
Post-treatments for oversize compound: aeraulic separator-optical separators
Final treatments: secondary shredding, pressing of the RDF and the recycled plastics in bales
Bio stabilized fraction produced: 32.900 t/year
Recycled plastics produced: 5.970 t/year
Recycled metals produced: 2.670 t/year



COMPOSTING PLANT FOR THE PRODUCTION OF COMPOST IN CASAL DI PRINCIPE

The project concerns the construction of a composting plant for the aerobic biological treatment of the organic fraction of municipal solid waste (OFMSW), collected separately, in order to allow the waste recovery through the production of high quality compost.

This plant falls within the scope of the interventions financed among 2014-2020 by the Campania Regional Operational Program (POR) based on the European Fund for Regional Development (ERDF).

The Joint Venture formed by Technital S.p.A., Owac Engineering Company S.r.l. and IA Consulting S.r.l. has awarded the Lot 2 (prov. CE) of the Framework Agreement and has signed the contract on 14/03/2019, Rep. N.14550.

The plant has an overall treatment capacity of 30.000 t/year, of which:

- 24.000 t/year dedicated to the treatment of the OFMSW;
- 6.000 t/year dedicated to the treatment/reuse of the wood-cellulosic fraction as structuring material in the biological process.

The OFMSW is mixed with the shredded structuring green and arranged in aerobic biocells for the accelerated biostabilization process (18 days). The treated compound is sent to the primary maturation process in ventilated lanes (45 days) and, following an intermediate refinement, is sent for the final maturation (27 days) in 6 static heaps periodically turned over. The obtained compound is ulterior refined to complete the process.

In the Project delivery, in order to limit the environmental and visual impacts of the plant in long and short terms/space, a full attention has given not only to the process layout design but even to:

- environmental mitigation measures
- landscape integration

It was decided to use colour as a camouflage tool. Eight colour nuances of the surrounding landscape are sampled and translated into RAL colours to be applied in the panels of the buildings. Such panels will be positioned alternating colours and gradation in order to camouflage the compost plant in the landscape.

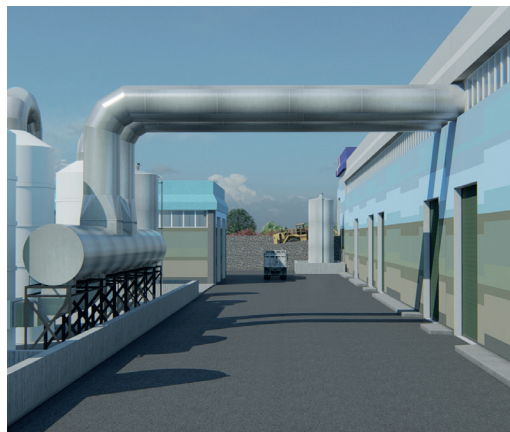

DESIGN DATA

Public client Campania Region
Type of service Definitive design
Project cost € 13.837,625,75
Location Casal di Principe (CE)
Total area 25.600 m²
Design period 2019

TECHNICAL DATA

Process typology: composting process in reinforced concrete biotunnel. Final maturation through dynamic aerated piles (STAGE 1) and static piles (STAGE2).

Capacity: 30.000 t/year
Produced compost: 8.700 t/year
Bio-cells: 5 of 550 m³ each
Primary maturation: 5 insufflate lanes
Second maturation: 6 turned heaps
Final refinement: compost screening and oversize deplastification
Biofiltration section: 1.200 m²
Air treated volume: 180.000 m³/h



COMPOSTING PLANT FOR THE PRODUCTION OF COMPOST IN CANCELLO E ARNONE

The plant falls within the umbrella of interventions financed by the Campania Regional Operational Program (POR) during the five-year period (2014-2020), which was enabled by the European Regional Development Funds (ERDF).

The RTP group, formed by Technital S.p.A., Owac Engineering Company S.r.l. and IA Consulting S.r.l. was awarded Lot 2 (EC prov.) of the Framework Agreement, signed on the 14th March, 2019, Rep. N.14550.

The project proposal envisages the construction of a composting plant that is expected to produce quality compost from the Organic Fraction of Municipal Solid Waste (OFMSW) to be subsequently used in the agriculture sector.

The designed plant has an overall treatment capacity of 30.000 t/year, of which:

- 24.000 t/year constitute the OFMSW;
- 6.000 t/year are wood-cellulosic waste fractions used as a structuring material that improves the biological composting process.

The OFMSW is mixed with the shredded structuring fraction and placed in aerobic bio-cells for the accelerated bio-stabilization (18 days). Later, the material is sent to primary maturation in ventilated lanes (39 days) followed by an intermediate refining. Then a final maturation process (33 days) is conducted placing the material in 6 static lanes in which it is periodically turned around. To finish, a final refinement is done.

Together with the design of the process and the environmental impact assessment (air, soil, water), we used sustainable architectural practices to provide a good landscape insertion of the building in order to mitigate visual impacts. Samples of the colours and shades of the neighbouring landscape were taken and matched with the European RAL colours matching systems. The external walls, rooftops and other relevant areas follow a precise chromatic order of colours with a degrading gradation so as to “blend” the plant into the landscape.



DESIGN DATA

Public client Campania Region
Type of service Definitive design
Project cost € 19.229.071,09
Location Canello e Arnone (CE), Italy
Total area 65.000 m²
Design period 2019

TECHNICAL DATA

COMPOSTING OFMSW SECTION

Type: composting process in reinforced concrete tunnel and final maturation through dynamic aerated heaps (PHASE 1) and static piles periodically turned over (PHASE 2)

Treatment capacity: 30.000 t/year
Process duration: 90 days
Produced compost: 9.637 t/year
Exhausted-air treatment capacity: 270.000 m³/h
Final refining: compost screening and “deplastification”



REMEDICATION OF FUEL STORAGE TANKS - AUGUSTA (SR)

The fuel storage in the district Punta Cugno was established in 1930 and is located in an area of about 800.000 square meters along the west coast of the port of Augusta (SR). It is owned by the Italian State and it is used by the Italian Navy.

The site includes five state-owned areas that identify five groups of tanks for a total storage capacity of approximately 240.000 tonnes of naval fuel and no. 2 logistics areas with five piers.

The five groups of fuel storage tanks are currently disused and in a very bad state of conservation that has led to leakage of combustible residues.

The area is part of the National Interest Site (SIN) of Priolo-Augusta which extends into the municipalities of Augusta, Priolo, Melilli and Siracusa; the SIN has also been declared "Area of high risk of environmental crisis" since 1990.

The activities planned for the remediation of the site consist of:

- a preliminary general survey with the production of a detailed catalog of the structures, the identification of any waste and the assignment of the respective CER codes;
- a topographic survey carried out by both drone, equipped with GPS, for an overall assessment and a Total Station for detailed evaluations;
- a detailed survey of the tanks with a detailed quantitative and qualitative evaluation of the waste present inside tanks and tunnels. An assessment of the degradation status of the structures will also be done by ultrasonic thickness measurements;
- the drafting of a final and executive project for the site remediation (fuel storage tanks, oil pipelines and tunnels) and disposing of all waste;
- the drafting of an environmental characterization plan in order to identify any contaminated areas.

DESIGN DATA

Public client

Italian Minister of Defence -
Navy Direction Augusta (SR)

Type of service definitive and executive design, safety coordination and construction management

Project cost € 20.219.887,83

Location Augusta (SR)

Site area 800.000 m²

Design period 2019

TECHNICAL DATA

Main activities:

- Preliminary investigations
- Topographic survey
- Thickness surveys
- Mapping, collecting and disposing of waste and disused structures
- Environmental characterization plan





LEACHATE TREATMENT PLANT IN CATANIA

The project involves the construction of a leachate treatment plant serving the entire landfill site located in c.da Codavolpe (CT), owned by Sicula Trasporti.

In the authorized treatment plant the leachate coming from the landfill is processed as follows:

- equalization and preliminary sedimentation of rough materials of coarse solids;
- ultrafiltration;
- 3-stage reverse osmosis;
- reverse osmosis at high pressure (for concentrate).

The leachate is temporarily stored inside the storage units and it is pumped inside an equalization tank which has buffer function to homogenize the wastewater to be treated inside this tank, moreover, the sedimentation of the suspended solids of larger dimensions takes place.

From the tank, the leachate is pumped into the filtration section, for the separation of the remaining suspended solids; the permeate from this treatment step is pumped into a feed tank for the subsequent reverse osmosis phases, while the UF concentrate is sent back into the accumulation tank.

The UF permeate then undergoes reverse osmosis treatment divided into three distinct phases; in each of them, in any case, the pressure applied to the fluid allows the separation of dissolved solids in the passage through the membranes.

Finally, from the third reverse osmosis stage, the permeate, which is purified from all the polluting components of the untreated leachate, is discharged into the underground storage tank. The treatment plant is completely automatic and also provides the possibility of remote control and telediagnosis; the plant is equipped with one MMI interface and SCADA system.

DESIGN DATA

Private client

SICULA TRASPORTI s.r.l.

Type of service Executive planning and construction management

Project cost € 4.100.000,00

Location c.da Grotte S. Giorgio, Lentini (SR)

Design period

October 2018 - August 2019

TECHNICAL DATA

Treatment capacity:

500 m³/day

Clarified permeate:

430 m³/day

Amount of concentrate:

70 m³/day





COMPOSTING PLANT IN MELILLI

The plant is authorized for the treatment and recovery of biodegradable organic waste for a maximum quantity of 45.000 t/year, in order to obtain high quality compost and natural fertilizers.

The plant is equipped with all the facilities and equipment necessary to ensure both the correct performance of the composting operations of the organic matrixes conferred and the adequate level of safety of the plant itself and of the surrounding areas (in terms of environmental emissions and human health).

The activities within the plant can be divided into:

- storage and mechanical pre-treatment of incoming waste;
- accelerated aerobic biostabilization in biocells;
- intermediate screening of the material;
- a first phase of maturation in aerated piles;
- final refining and second phase of maturation;
- storage of the finished product.

Mitigation works of environmental impacts related to the treatment process performed in the plant are designed:

- exhaust air treatment, sized for a flow rate of 280.000 m³/h; this system consists of 3 scrubbers equipped with two electric fans each. The air is then humidified and dedusted and in the passage through the biofilter also the volatile organic substances and odorigene are cut down within the limits of the law
- separate collection and management of rainwater, wastewater and leachates;
- adequate waterproofing system below all areas for handling, storage and treatment of waste composed as follows: layer of foundation ground regularization; WNW protection; 2.5 mm thick HDPE geomembrane; drainage geocomposite (consisting of WNW, geogrid and WNW); mixed layer of final regularization.

DESIGN DATA

Private client SICULACOMPOST s.r.l.

Type of service Executive design and construction management

Project cost € 24.77.000,00

Location Melilli, c.da Santa Catrini (SR)

Surface 48.537 m²

Design period September 2018
- in progress

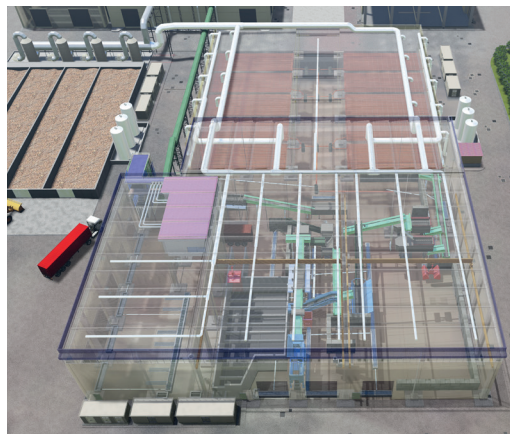

TECHNICAL DATA

ACCELERATED BIO-OXIDATION

Biocells: no. 10, 550 m³ each

Average process period: 28 days

Total process duration: 90 DAY

Potential: 45.000 t/year

Working days: 350 d/year

Compost produced: 14.000 t/year



PLANT FOR THE **TREATMENT OF OFMSW** (ORGANIC FRACTION OF MUNICIPAL SOLID WASTE) AND **M.S.W** (IN A STAND ALONE CONFIGURATION) IN CALATAFIMI

The project concerns the construction of a plant in a stand-alone configuration, consisting of both anaerobic digestion section of the organic fraction deriving from the separate collection of urban waste (OFMSW) with bio-methane production (energy recovery) and quality compost (material recovery) and a mechanical-biological treatment section of mixed municipal solid waste (M.S.W) for the recovery of materials / products and energy for the plant's self-consumption. The plant has a maximum treatment capacity of 65.000 t/year for the OFMSW treatment section and 80.000 t/year for the M.S.W treatment section. The project therefore envisages the conduct of waste management operations R3 - R4 - R13 - D8 - D13 - D15 as indicated in Annex B and C of the fourth part of Legislative Decree 152/2006. The activities that take place within the plant can be divided as follows:

A. OFMSW TREATMENT SECTION

- Mechanical pretreatments
- Anaerobic digestion, biogas production, biomethane refining
- Production of quality compost

B. M.S.W TREATMENT SECTION

- Mechanical separation treatments;
- Anaerobic stabilization, biogas production, energy cogeneration
- Aerobic biostabilization of organic waste
- Material recovery
- RDF production

The organic treatment of OFMSW produces a high quality compost equal to about 21.000 t/year and biomethane production equal to about 490 Sm³/h. In the M.S.W treatment section we obtain a quantity of stabilized organic fraction (O.F) about 19.000 t/year, recyclable materials about 22.000 t/year and a biogas production about 430 Nm³/h.

DESIGN DATA

Private client OWAC S.R.L
Type of service Definitive design
Project cost € 36.830.000,00
Location Calatafimi - Segesta (TP)
Tot area 66.750 m²
Design period 2018

TECHNICAL DATA

OFMSW treatment section
Capacity: 65.000 t/year
Process duration: 90 days
Anaerobic digester: No.2, 1.800 m³ each
Bio-cells for aerobic stabilization: No. 9, 500 m³ each
Maturation of basement: No. 4, 2.400 m³ each
Compost produced: 21.200 t/year
Biomethane produced: 490 Sm³/h

MSW treatment section

Capacity: 80.000 t/year
Duration for stabilization of organic fraction: 38 days
Aerobic bio-cells: No. 7, 400 m³ each
Bio-cells anaerobic: No. 4, 400 m³ each
Post-treatments: pressing of plastic material and shredding for RDF
Stabilized organic fraction produced: 19.200 t/year
Recoverable plastics produced: 21.300 t/year
Recoverable metals produced: 800 t/year
Biogas produced: 430 Nm³/h





ENLARGEMENT OF A BIOSTABILIZATION PLANT IN CATANIA

The project of enlargement Sicula Trasporti S.r.l. plant is designed to cope with the ever increasing demand for specific treatment of the mechanical selection of undifferentiated waste.

In particular, the project involves the construction of a new section of aerobic biostabilization of the under screen waste from the undifferentiated urban waste selection plant.

This plant section involves the construction of two bio-tunnel batteries, each of which consists of n. 16 polyethylene tubular containers with forced air recirculation, inside which the biostabilization of the incoming waste will take place.

The project envisages an increase in the treatment potential capacity of aerobic biostabilization of non-hazardous waste equal to 100.000 t/year. This capacity will be added to the current one of 315.000 t/year, for a total capacity of 415.000 t/year.

For the new enlargement section, it was decided to adopt the technology of biostabilization in aerated static heaps, using a polyethylene bio-tunnel in order to make the plant operative in a short time, given the emergency in the field of management and treatment of urban waste in Sicily.

The materials/waste leaving the plant will consist of:

- non-specific compost, identified with CER 19.05.03, for an expected average quantity of about 300.000 t/year (of which about 220.000 t/year currently produced in the existing plant);
- leachate, code CER 19 07 03, for an expected average quantity of about 6.000 m³ year from the existing section and about 3.700 m³/year from the new project section (to be disposed of with authorized plant).



DESIGN DATA

Private client SICULA
TRASPORTI s.r.l.

Type of service Executive
planning and construction
management

Project cost € 3.200.000,00

Location Catania, c.da
Codavolpe (Italy)

Total area 29.700 m²

Design period June 2018

TECHNICAL DATA

ACCELERATED BIO-OXIDATION

Bio-cells: No 32, 275 m³ each

Total period: 21 days

Potentiality: 10.000 t/year

Working days: 350 d/year



COMPOSTING PLANT FOR THE PRODUCTION OF COMPOST IN CATANIA

The proposed plant layout has the main objective to develop the production of compost, obtained through a biological treatment of the organic fraction of the waste coming from the separate collection.

The plant, authorized with D.D.S. n. 120 of 12/02/2014 and subsequent D.D.G. n. 1212 dated 05/09/2016, has a maximum capacity of 70.000 t/year has been defined for waste R13 and R3 as indicated in Annex C of the fourth part of Legislative Decree No. 152/2006.

The different activities that take place inside can be defined as follows:

- provision and mechanical pre-treatment of waste;
- accelerated bio-oxidation in aerated static heaps;
- ripening in upturned and aerated heaps.

The duration of the biological process must not be less than 90 days and in the first phase includes a accelerated bio-oxidation, followed by a second phase of maturation in heaps. The process technology for accelerated biooxidation is a static type with forced aeration of the material and takes place within n. 10 biocells in reinforced concrete ensures a rapid opening / closing of doors.

The maturation phase takes place inside a shed where 10 heaps are placed which are periodically turned by means of a revolving means.

Finally the material is screened for a final refining: the overage is used as a structuring and the under-size materials are placed in static heaps until the days necessary for stabilization are reached.

The quantity of product is about 21.000 t/year and is stored under a side-opened steel structure with a perimeter wall of 3,00 m height. The plant has been classified by a series of systems for the mitigation of emissions in the various environmental sectors that the activity in question could generate.

DESIGN DATA

Private client Sicula Compost
Type of service Executive planning
Project cost € 14.726.000,00
Location C.da Grotte S. Giorgio (CA)
Lot area 27.000 m²
Design period August 2017 - March 2018
Entered into operation May 2018

TECHNICAL DATA

Operations pursuant to all. B and C in Part IV of Legislative Decree 152/06 and subsequent amendments R3, R13
Type: composting process in biotunnel in reinforced concrete and final maturation through aerated (STAGE 1) and static dynamic piles (PHASE 2).
No. 1 building for composting tunnels: dimension 65 x 55 m
No. 1 building for the conferment and treatment of waste: dimension of 100 x 35 m
No. 10 composting tunnel (ACT PHASE): dimension 12.50 x 21.60 m each
No. 10 aerated and turned up piles: dimension 4 x 2.7 x 40 m each
Average process duration: 90 days





ENLARGEMENT OF AN EXISTING COMPOSTING PLANT IN AGRIGENTO

The proposed plant layout has the main objective to develop a new and larger configuration of an existing composting plant for organic waste treatment and high-quality compost production. The project also provides the technology improvement for the process.

The enlargement of the existing plant consists in the construction of a new building in which the composting process will start inside no. 12 closed tunnels (process period 4 weeks).

After the intense composting phase, the material will be moved to the final maturation section (after screening operation). This phase will occur in dynamic windrows subjected to forced ventilation inside a closed concrete building. A further final maturation phase is also provided through static windrows, so that the composting process can be completed, obtaining a high-quality compost for sales.

The project provides an increase of the composting treatment capacity equal to 30.000 t/year, which increases, together with the existing authorized capacity 26.000 t/year (AIA authorization released by D.D.S. n. 1897 del 12/11/2014 for R3, R13 operation), the plant capacity up to 56.000 t/year.

DESIGN DATA

Private client GIGLIONE SERVIZI ECOLOGICI s.r.l.
Typology composting process in bio-tunnel and final maturation by air-forced and dynamic/static windrows.
Project cost € 11.528.753,90
Location Manica Lunga district – JOPPOLO GIANCAXIO (AG)
UTM Coord. (Zone 33S) 374,370 E - 4,135,751 N
Site area 72.000 m²
Existing plant surface 2.100 m²
New plant surface 17.138,31 m²
Task assigned and carried out Preliminary and Final design
Enlargement designing period March 2017

TECHNICAL DATA

Operations according to Encl. B and C referring to Part IV of Law Decree No. 152/06 (D.Lgs. 152/06) and further amendments D9, R3, R13.
New treatment capacity: 56.000 t/year
No. 1 building for composting tunnel: dimensions 38 x 90 m
No. 12 composting tunnels (ACT phase): dimensions 6 x 32 m each
No. 9 air-forced and dynamic windrows: dimensions 5 x 2.7 x 49 each
No. 3 static windrows: 1.600 m³ each
Average process period: 90 days



IMPROVEMENT OF AN EXISTING AEROBIC BIOSTABILIZATION PLANT IN CATANIA

The proposed project comes from the need of the company Sicula Trasporti s.r.l. to increase the treatment capacity of the ever-growing amount of undersieve waste produced by mechanical selection of mixed waste. In particular, the enlargement of the existing plant consists of a new section of aerobic biostabilization of undersieve originated from mixed waste treatment plants.

In this section, the aerobic biostabilization will occur through dynamic windrows subjected to forced ventilation, inside two closed concrete sheds.

These sheds will be kept in aspiration with no. 3 hourly air changes; exhaust air will be conveniently treated.

The project provides an increase of the aerobic biostabilization treatment of non-hazardous waste amount equal to 150.000 t/year.

This new capacity, together with the existing authorized one which is 315.000 t/year, increases the plant capacity up to 465.000 t/year (operation D8 according to Encl. B and C referring to Part IV of Law Decree No. 152/06 (D.Lgs. 152/06) and further amendments.

DESIGN DATA

Private client

SICULA TRASPORTI s.r.l.

Typology

aerobic biostabilization for air-forced and dynamic windrows.

Project cost € 14.789.776,01

Location Catania

UTM Coord. (Zone 33S) 505,850

E - 4,1387,495 N

Site area 113.000 m²

Existing plant surface
36.000 m²

New plant surface 34.500 m²

Task assigned and carried out

final design, environmental impact preliminary assessment, integrated environmental Authorization application

Existing plant construction

period April 2010 - August 2012

Enlargement designing period

December 2016

TECHNICAL DATA

Operations according to Encl. B and C referring to Part IV of Law Decree No. 152/06 (D.Lgs. 152/06) and further amendments D8, R3

New treatment capacity:
465.000 t/year

No. 2 building: dimensions 60.00 x 110.00 m and 70.00 x 110.00 m, net height of 8.00 m, both)

No. 22 air-forced and dynamic windrows: 600 m³ each

Average process period: 21 days

Air blowing system: building A, no. 14 centrifugal fans 45 kW each; building B, no. 14 centrifugal fans 55 kW each.





ORGANIC WASTE TREATMENT PLANT WITH **BIOMETANE PRODUCTION** IN CATANIA

The project provides the construction of an anaerobic digestion plant for organic waste resulting from separated collection of MSW (OFMSW), with production of biomethane. The digested sludge will be treated for compost production. The main objective of this project proposal is to limit negative effects on environmental and human health resulting from the MSW management. The project is in accordance with EU's objectives regarding recycling of waste and the reduction of waste landfilling.

For this reason, municipalities have been activated measures to increase the MSW separate collection in accordance with the first subparagraph of article 32 (1C) of Italian D.Lgs. 152/2006 and European directive 2008/98/EC.

In accordance with the waste hierarchy established by art. 4 of the European directive and the purpose of reducing greenhouse gas emissions by landfilling, easier separate collection and an appropriate waste treatment are planned, in order to produce organic materials without negative impacts on the environment.

The project is composed of two main working areas inside two existing buildings, located in Catania's industrial area.

The activities that will take place in the plant are: waste storage and mechanical pre-treatment; anaerobic digestion; treatment of the digested sludge; biogas upgrading; exhaust air and liquid waste treatment.

The project provides waste treatment capacity equal to 57.000 t/year, of which 45.000 t/y are OFMSW and 12.000 t/y are green waste used as bulking material during the digested sludge maturation phase.

DESIGN DATA

Private client

SICULA TRASPORTI s.r.l.

Task assigned and carried out

preliminary and final design

Cost € 21.683.382,40

Location Catania (Italy)

UTM Coord. (Zone 33T)

502,872 E - 4,493,845 N

Site area 31.000 m²

Shed surface 6.600 m²

Design period 2016

TECHNICAL DATA

Treatment: mechanical pre-treatment, anaerobic digestion and aerobic stabilization (composting)

Anaerobic digestion: no. 2 digesters (dry process) 2.250 m³ each

Aerobic biostabilization of digestate: no. 4 closed tunnels (7 x 24 m each)

Average process period: 90 days

Air forced system: no. 4 blowers 45 kW power and 10.000 Nm³/h flow rate each

Air treatment: 80.000 Nm³/h (wet scrubber and biofilter - 600 m²)



ENLARGEMENT OF A LANDFILL FOR NON-HAZARDOUS WASTE IN LENTINI

The project incorporates the landfill site enlargement, first by the construction of a third cell nearby the existing authorised A and B cells, with an approximate volume of 970.000 m³. The second schedule enlargement stage employs the available intercell spaces accomplishing the restoration of the original orography of the site. After the closure of existing cells, a temporary capping will be done before implementing the second enlargement.

Analogous to constructed cells, the enlargement cell will be equipped with a double collection system for leachate generated within the landfill. This system counts with a main upper-network for regular leachate accumulation and a secondary lower-network which serves as a backup.

Each cell has a leachate collection pipe network with corresponding sumps in order to convey the leachate by pumping it into different steel tanks situated inside concrete containment vessels to avoid accidental leachate spills.

The leachate treatment facility situated within the landfill site, implements ultrafiltration and reverse osmosis technology. The treated water is discharged into water-bodies while the concentrate sludge is pumped over the upper landfill section through a specific infiltration system.

After the closure of cells A and B a landfill gas management system will be implemented for the extraction and collection of biogas through vertical wells, extraction substations for the condensate discharge and pumping to the electrical generation system consisting of endothermic engines.

DESIGN DATA

Private client
SICULA TRASPORTI s.r.l.
Task assigned and carried out
Final design and Environmental Impact Assessment
Cost € 39.746.030,62
Location Lentini (SR)
UTM Coord. (Zone 33S) 502,745 E - 4,135,703 N
Surface of the new basin
30,600 m²
Volume of the new basin
971.540 m³
Total volume 2.886.103 m³
Available volume with the reprofiling 3.791.511 m³
Project period 2016

TECHNICAL DATA

TREATMENT
Maximum potentiality: 700.000 t/year
Expected operating life: 6 years
Days of disposal per year: 320
Maximum expected leachate production: 50 m³/day
Maximum expected biogas production: 10÷30 Nm³/ton waste x year
ACCESSORY EQUIPMENT
• Leachate treatment system with a potentiality of 50 m³/day
• Biogas treatment
• Cogeneration system for the production of electricity





RECYCLABLE MATERIAL SORTING PLANT IN EBOLI

In order to operate an integrated management of municipal solid waste, the designed plant is aimed to both maximize the recovery of materials and prepare a fuel from waste, the refuse-derived-fuel (RDF). The maximum treatment capacity amounts to 300.000 t/y. The machinery layout is arranged in three lines for the mechanical sorting of municipal waste, having a total treatment capacity of 365 t/d; the system comprises: a wide storage area for incoming waste, a hopper and two pre-shredders that make the material dimensions adequate for the following sorting phases (dimensions less than 200 mm) and two vibrating screens to separate two flows of materials, the underscreen one, that is smaller than 30 mm, and the upper screen one, from which ferrous metals and non-ferrous metals (e.g. aluminum cans) are also separated. The upper screen fraction is also subjected to air separation, optical separation and manual sorting in order to select plastics for recycling (PE, PET, etc.). Lastly, the driest fraction separated from the incoming waste is sent to a fine shredding section for producing the RDF, a high-calorific-value fuel, which is baled and sent to thermal plants. A fourth line, consisting of a rotating screen, is also set up to treat the roadside waste from the urban roads weeping activities. The factory shed is constantly kept under negative pressure in order to ensure the health of the workplace. The air treatment system is constituted by a wet scrubber system.

DESIGN DATA

Private client
SICULA TRASPORTI s.r.l.
Task assigned and carried out
Final design
Cost € 10.405.344,69
Location Eboli (SA)
Site surface 20.160 m²
Shed surface 4.780 m²
Project period 2016

TECHNICAL DATA

Operations according to Encl. B and C referring to Part IV of Law Decree No. 152/06 (D.Lgs. 152/06) and further amendments R3, R4, R12, R13
Maximum capacity: 300.000 t/year

Average capacity: 127.000 t/year

Sorting lines:

1. dry mixed waste from MSW separate collection (80.000t/y);
2. mono-material waste from MSW separate collection (12.000 t/y);
3. multi-material waste from MSW separate collection (25.000 t/y);
4. urban roadside waste (10.000 t/y);

Working days per year: 350
Personnel: 22

ACCESSORY EQUIPMENT

Air treatment: 160.000 Nm³/h

Air treatment system: wet scrubbers

Air treatment surface: 130 m²

Air treatment system in the manual sorting area: 1.200 Nm³/h

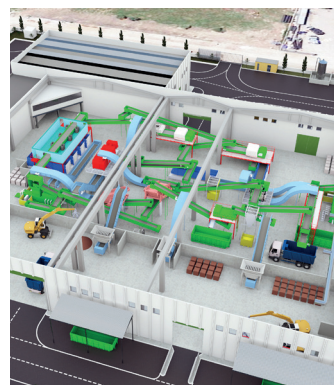



INDUSTRIAL DISTRICT PRELIMINARY DESIGN AT DISUSED “SISVA” STEELWORKS IN CALVISANO

The proposed solution provides the conversion of a disused industrial site, a former steelworks plant that becomes a multifunctional platform for the community, paying attention to social issues, such as electricity production from renewables resources. One of the principal advantages of this site is the internal railway junction which offers a logistic alternative for road transport resulting in other benefits. Other advantages could be achieved if cross-border transportation would be implemented, obtaining useful and strategic industrial operations.

The project consists in the construction of two treatment lines for the separate collected dry waste to produce the RDF in the already existing building. Furthermore, a section for the aerobic biostabilization of organic underscreen waste coming from mechanical sorting of mixed urban waste will be built. In prospect of a future increase in separate collection of urban waste, a section for anaerobic digestion is planned too; the produced biogas will be exploited for cogeneration (combined production of heat and electricity) using endothermic engines. The project also consists of a biomass power plant for woodchips treatment. Therefore, the factory represents a stand-alone platform while social targets such as reducing the treatment costs of community waste and reducing the emission of green house gases will be achieved.

Considering the goals of the project and the existing buildings on the site, the construction of internal laboratories for the factory management is planned, as well as the creation of a learning and development centre to provide training courses and applied research in cooperation with universities.

DESIGN DATA

Private client TRAILERI s.p.a.
Task assigned and carried out Preliminary design
Cost 47.631.955,00 €
Location Calvisano (BS)
Coord. UTM (Zone 32 T) 604,640 E – 5,024,618 N
Site area 120.000 m²
Buildings surface 8.000 m²
Design period 2015

TECHNICAL DATA

Refuse derived fuel (RDF) production: mechanical separations, with metals and plastics recovery and RDF production.
Capacity: 120.000 t/year.
Organic underscreen treatment: aerobic biostabilization in air-forced dynamic windrows.
Capacity: 60.000 t/year.
Organic waste treatment: anaerobic digestion and composting of the digested sludge.
Capacity: 30.000 t/year.
Biogas cogeneration: 1 MWe
Biomass power plant: < 1 MWe





IMPROVEMENT OF AN EXISTING COMPOSTING PLANT IN CATANIA

The design for improving the existing aerobic biostabilization plant (authorized by the Italian Decree that regulates integrated environmental authorizations - D.R.S. 1004/2009) was devised for two different needs:

- i) to balance the waste treated with the waste produced by and arriving from the mechanical treatment plant (which was authorized by D.R.S. No. 248 26/03/2009 to treat 1.000.000 t/y of undifferentiated urban waste);
- ii) to provide a new section of the facility to be used for the treatment of organic waste from the separated collection of MSW, in accordance with the new target (>65% separate waste sorting) of the “Regional Plan for the management of Municipal Solid Waste of May 2012”.

The design regards the construction of:

- a new section for the aerobic treatment of the underscreened materials resulting from mechanical selection, having a maximum capacity of 150.000 t/y, equal to about 410 t/d (static heaps will be stabilized within 23 closed tunnels, and subject to forced ventilation). This will increase the current capacity from 315.000 to 465.000 t/y. So the treatment capacity will be adequate to process the organic waste (about 450.000 t/y) arriving from the mechanical plant.
- a new section for the anaerobic digestion of the organic waste resulting from separate collection of MSW with production of compost, with a maximum capacity of 75.000 t/y, which are about 205 t/d (process phases: mechanical pretreatments, anaerobic digestion, within 13 closed tunnels, for the production of biogas which is recovered within a 1.5 MW cogeneration, stabilization and drying of the digested sludge, within 13 closed tunnels subject to forced ventilation).

DESIGN DATA

Private client
SICULA TRASPORTI s.r.l.

Tasks assigned and carried out
Preliminary and final design for the Integrated Environmental

Cost € 51.359.406,90

Location Catania

Site area 113.000 m²

Pre-existing plant surface
36.000 m²

Additional surface for new plant 66.700 m²

Pre-existing facility construction period October 2010 - August 2012

Designing of enlargement project from March to november 2014

TECHNICAL DATA

ACCESSORY EQUIPMENT

Average biogas production:
5.844.000 m³/year

Cogeneration system: one internal combustion engine, 1.560 kWe and off-gas thermal recovery (1.640 kWt)

New treatment capacity:
465.000 t/year (underscreen material);
75.000 t/year (organic waste from separate collection of M.S.W.)

Number of anaerobic tunnels:
13 tunnels (550 m³ each),

Number of aerobic tunnels: 36 tunnels, (550 m³ each)

Average process period: 90 days for high-quality compost; 21 days for off-specification compost





INTEGRATED M.S.W. TREATMENT PLANT - ENNA

The design is developed in accordance with a public tender for the construction of an integrated system for the M.S.W. management in the Municipality of Enna (CIG 5533376E50), which was issued by the Commissioner for the Waste Emergency in Sicily (O.P.C.M. 9/7/2010 n. 3887 - D.L. n. 43/2013). The plant lay-out provides one mechanical treatment line for the screening of M.S.W. with a capacity of 31.4 t/h. The process-line layout is the following: a wide area for the storage of the incoming wastes, a shredding and a double-stage screening (with holes from 130 to 80 mm). This is aimed to separate the following materials:

- i) oversize fraction >130 mm, by which nonferrous metals (e.g. aluminium cans) and ferrous materials will be separated;
- ii) oversize fraction 80÷130 mm, by which ferrous materials will be separated;
- iii) underscreen fraction < 80 mm, which must be processed with biological treatment.

The designed layout also provides the possibility of future development of a fine shredding section for producing RFD from high calorific fractions. Provided biological treatments for the underscreen fractions are:

- 1) anaerobic digestion to obtain biogas which can be recovered into a cogenerator engine for the production of electricity and thermal energy (supplied for the self-consumption of the plant);
- 2) aerobic stabilization of the digested sludge to obtain a stable dry material which can be sent to disposal or recycled.

The buildings will be kept in constant depression in order to ensure the health of workers; the air is recirculated within the aerobic tunnels to facilitate the biological process.

Lastly, the exhaust air will be treated with a scrubber and a biofilter, and so treated air can be given off into the atmosphere, since pollutant concentrations are reduced to the levels set forth by law.

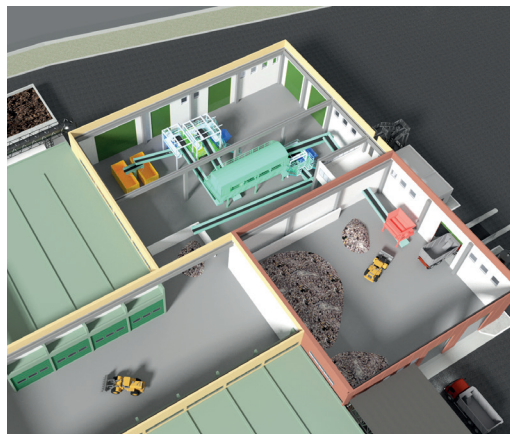

DESIGN DATA

Public client

Commissario Delegato per l'emergenza Rifiuti in Sicilia (ex O.P.C.M. 9/7/2010 n. 3887 - D.L. n. 43/2013)

Tasks assigned and carried out
Final design

Cost € 11.836.978,51

Location C.da Cozzo Vuturo (EN)

UTM Coord. (Zone 33S) 438,258 E - 4,161,038 N

Site area 41.000 m²

Shed surface 3.400 m²

Design level Final design

Designing period 2014

TECHNICAL DATA

Operations according to Encl. B and C referring to Part IV of Law Decree No. 152/06 (D.Lgs. 152/06) and further amendments D8, D9, D14, D15, R1, R3, R4, R5, R13.

Potential capacity: 50.000 t/year; 314 t/h

Treatment lines: one

Mechanical pretreatment:

shredding - double screening (130 mm and 80 mm) - ferrous and nonferrous metals recovery

Biological treatment: anaerobic digestion of underscreen materials (seven tunnels, dimensions 6x30 m each) biological stabilization and drying of the digested sludge (four tunnels, dimensions 6x30 m each)

Leachate storage: 1.500 m³

ACCESSORY EQUIPMENT

Air treatment: 80.000 Nm³/h

Air treatment system: wet scrubber and biofilter

Biofilter surface: 600 m²

Biogas cogeneration system: 600 kW endothermic engine biogas purification system

Expected biogas flow rate: 300 m³/h

Expected electrical energy production: 3.400 MWh/y

Expected thermal energy production: 3.700 MWh/y



INTEGRATED M.S.W. TREATMENT PLANT - MESSINA

The plant design is developed in accordance to a public tender for the construction of an integrated system for the M.S.W. management in the Municipality of Messina (CIG 55388378E1), which was issued by the Commissioner for the Waste Emergency in Sicily (O.P.C.M. 9/7/2010 n. 3887 - D.L. n. 43/2013). The plant lay-out provides one mechanical treatment line for the screening of M.S.W. with a capacity of 32.1 t/h, 12 hours/day. The process-line layout is the following: a wide area for the storage of the incoming wastes, a shredding and a double-stage screening (with holes from 130 to 80 mm).

This is aimed to separate the following materials:

- i) oversize fraction >130 mm, by which nonferrous metals (e.g. aluminium cans) and ferrous materials will be separated;
- ii) oversize fraction 80÷130 mm, by which ferrous materials will be separated;
- iii) underscreen fraction <80 mm, which must be processed with biological treatment.

The designed layout also provides the construction of a landfill with a capacity of 270.000 m³ which will be used for the final disposal of the fraction deriving from the mechanical treatment, and the construction of a leachate treatment system, which is constituted by an ultrafiltration and four-steps reverse osmosis sections for completely purifying the wastewater.

The underscreen fraction deriving from the mechanical treatment will be processed within aerobic biological tunnels, which are closed and air forced with blowers, in order to obtain stable and dry materials which can be sent to disposal or recycled.

The buildings will be kept in constant depression in order to ensure the health of workers; the air is recirculated within the aerobic tunnels to facilitate the biological process.

Lastly, the exhaust air will be treated with two scrubbers and a biofilter, and so treated air can be given off into the atmosphere, since pollutant concentrations are reduced to the levels set forth by law.

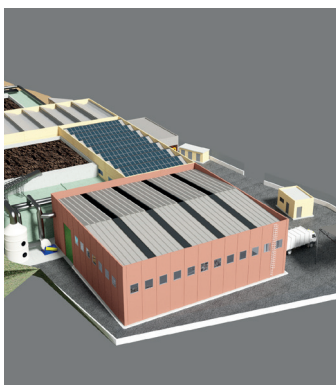

DESIGN DATA

Public client

Commissario Delegato per l'emergenza Rifiuti in Sicilia (ex O.P.C.M. 9/7/2010 n. 3887 - D.L. n. 43/2013)

Tasks assigned and carried out Final design

Cost: € 11.868.548,20

Location C.da Pace (ME)

UTM Coord. (Zone 33S) 549,820 E - 4,233,230 N

Site area 39.300 m²

Shed surface 2.400 m²

Landfill surface 23.420 m²

Design level Final design

Designing period 2014

TECHNICAL DATA

Operations according to Encl. B and C referring to Part IV of Law Decree No. 152/06 (D.Lgs. 152/06) and further amendments: D1, D8, D9, D14, D15, R3, R4, R5, R13.

Potential capacity: 102.200 t/y; 32.1 t/h

Treatment lines: one

Mechanical pretreatment: shredding - double screening (130 mm and 60 mm) - ferrous and nonferrous metals recovery

Biological treatment: aerobic stabilization of underscreen materials (seven tunnels, dimensions 8x35 m each)

Landfill disposal: 278.600 m³, lifetime 43 months

ACCESSORY EQUIPMENT

Air treatment: 120.000 Nm³/h

Air treatment system: two wet scrubbers and one biofilter (partitioned into two sections)

Total biofilters surface: 960 m²

Leachate treatment system: ultrafiltration and four-phases reverse osmosis, maximum L

Leachate flow rate: 60 m³/d

Leachate storage: 350 m³

Clarified effluent: surface drain within the levels set forth by Italian law (D.Lgs. 152/06)



INTEGRATED M.S.W. TREATMENT PLANT - GELA

The design is developed in accordance to a public tender for the construction of an integrated system for the M.S.W. mechanical and biological treatment in the Municipality of Gela (CIG 553112900C), which was issued by the Commissioner for the Waste Emergency in Sicily (O.P.C.M. 9/7/2010 n. 3887 - D.L. n. 43/2013). The plant lay-out provides two mechanical treatment lines for the screening of M.S.W. with a capacity of 31.4 t/h overall. The process-line layout is the following: a wide area for the storage of the incoming wastes, two screens with 300 mm holes for the separation of non-treatable waste, two shreddings and double-stage screenings (with holes from 130 to 80 mm). This is aimed to separate the following materials:

- i) oversize fraction >130 mm by which nonferrous metals (e.g. aluminium cans) and ferrous materials will be separated;
 - ii) oversize fraction 80÷130 mm, by which ferrous materials will be separated;
 - iii) underscreen fraction <80 mm, which must be processed with biological treatment.
- Oversize materials will be also processed with ballistic and optical separation in order to separate paper and recyclable plastic materials.

The designed layout is also arranged for future development of a fine-shredding section to produce RDF, a refining section for the bio-stabilized materials, and a recovery section for the organic waste from separated collecting of MSW (for producing high-quality compost). The biological treatment for under screen fractions is aerobic stabilization within closed air-forced tunnels, in order to obtain stable and dry materials which can be sent to disposal or recycled. The buildings will be kept in constant depression in order to ensure the health of workers; the air is recirculated within the aerobic tunnels to facilitate the process. Lastly, the exhaust air will be treated with two scrubbers and a biofilter, and be given off into the atmosphere, since pollutant concentrations are reduced to the levels set forth by law.

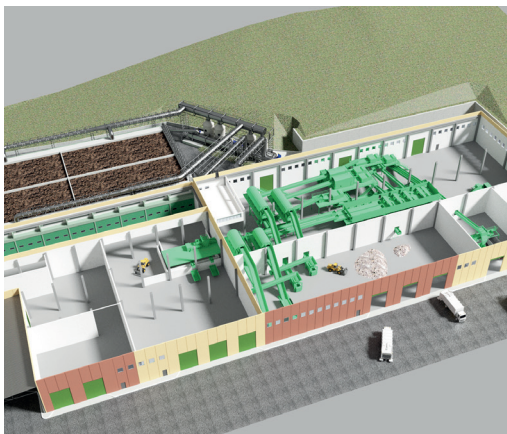

DESIGN DATA

Public client

Commissario Delegato per l'emergenza Rifiuti in Sicilia (ex O.P.C.M. 9/7/2010 n. 3887 - D.L. n. 43/2013)

Tasks assigned and carried out

Final design

Cost € 21.690.737,80

Location C.da Timpazzo - Gela (CL)

UTM Coord. (Zone 33S) 439,794 E - 4,113,270 N

Site area 43.000 m²

Shed surface 11.300 m²

Design level Final design

Designing period 2014

TECHNICAL DATA

Operations according to Encl. B and C referring to Part IV of Law Decree No. 152/06 (D.Lgs. 152/06) and further amendments D8, D9, D14, D15, R3, R4, R5, R13.

Potential capacity: 60.000 t/y; 35.0 t/h

Treatment lines: Mechanical Pretreatment: two lines of screening at 300 mm - shredding - double screening (130 mm and 100 mm) - ferrous and nonferrous metals recovery - paper recovery - plastic recovery - recyclable materials pressing

Biological treatment: aerobic stabilization of under screen materials (nine tunnels, dimensions 8 x 40 m each)

ACCESSORY EQUIPMENT

Air treatment: 320.000 Nm³/h

Air treatment system: four wet scrubbers and one biofilter (partitioned into four sections)

Total biofilters surface: 2.560 m²

Future developments

prediction: final shredding section for RDF; final shredding section for biostabilized materials; high-quality compost production from organic fraction by separate collection.



REDEVELOPMENT PROJECT OF THE DISUSED INDUSTRIAL FACTORY “SNIA - VISCOSA” IN RIETI

The proposed solution focuses on the conversion of an industrial site formerly used for the viscose production into a multifunctional platform for the community utility, such as electricity production from renewables and other social themes.

Therefore, some recovery systems are designed:

- An anaerobic digestion section for organic waste resulting from separated collection;
- A mechanical treatment section for RDF production, metals and plastics recovery;
- An aerobic stabilization section for underscreen organic waste produced by mechanical sorting section.

Then, the following systems are designed to abide by the environmental policies and particularly renewable energy:

- Photovoltaic power plant
- Thermodynamic solar power plant;
- Small wind turbines power plant;
- Small hydroelectric power plant;
- Co-generator using biogas produced in the anaerobic digestion section;
- Gasification plant using the RDF to produce heat and electricity.

This site is very close to the town, so it is very interesting to provide a heat transfer system, using an appropriate heat transfer fluid. So advantages for the city are achieved. Lastly, an educational center will be implemented to cooperate with university departments to develop the explained environmental themes. This could help young people to remain in their territory, making the site to become an excellent place for the development of future skilled professionals.

DESIGN DATA

Private client

M.P.S. Leasing & Factoring
S.p.A.

Task assigned and carried out

Preliminary design and technical-economic feasibility study

Cost 50.000.000,00 €

Location Rieti

Coord. UTM (Zone 33 T) 323,318

E – 4,697,917 N

Site area 170.000 m²

Design period 2013

TECHNICAL DATA

Refuse Derived Fuel (RDF)

production plant: 15.000 – 18.000 t/year

Aerobic biostabilization plant: 16.000 t/year

Anaerobic digestion plant: 1 MW

Dynamic thermal solar plant: 30 kW

Photovoltaic plant: 1.5 MW

Gasification plant: 4 MW

PLASTIC RECYCLING PLANT

Total producible energy: 42 GWh/year



FUNCTIONAL IMPROVEMENT **LANDFILL 76** IN CATANIA

The re-design intervention has provided the functional improvement for morphologic structure by redistributing the original planned waste disposal volume for the non-hazardous waste landfill, situated in Grotte San Giorgio in Catania, authorized by the Regional Sicilian Decree D.D.G. No. 76 03/03/2010 (Integrated Environmental Authorization in accordance with the Legislative Decree D.Lgs. No. 152/06 and further amendments). After the approval of the functional improvement design, the authorization was modified in accordance with the decree D.D.G. No. 1244 07/26/2013.

The extension of the total site is 35.000 m², the cell occupies approximately 23.200 m² and with the remaining area holding auxiliary facilities including landfill gas and leachate management systems. The authorized landfill has an equivalent capacity of 1.000.000 m³, in a single hillside excavated cell, with a variable depth between 50 and 30 m, respectively upstream and downstream.

The operation stage of the landfill began in August 2012, during the filling an improvement of the original planned structure of the cell was required in order to maintain safety conditions regarding the operation of the haul-road for heavy vehicles transportation and disposing the waste within the cell, for this purpose the implementation of a new cell of approximately 5.850 m³ was required.

The new cell was constructed downstream of the original cell using subvertical walls (due to natural high strength of the excavated soil). Allowing the authorised volume preservation by decreasing original cell planned height. Furthermore, perimeter screening was constructed using large basaltic rocks and topped off with sand and calcarenite gravel, reaching 10-meter average height and a 6 meters upper-thickness with a 35 degrees slope.



DESIGN DATA

Private client SICULA
TRASPORTI s.r.l.
Tasks assigned and carried out
Final Design and Integrated
Environmental Authorization
application
Cost € 21.256.995,14
Location Catania (CT)
UTM Coord. (Zone 33S) 502,932
E - 4,135,702 N
Site area 35.000 m²
Dump basin surface 23.200 m²
Landfill volume 1.000.000 m³
Construction period 2010-2011
Designing period 2013

TECHNICAL DATA

Operations according to Encl. B and C referring to Part IV of Law Decree No. 152/06 (D.Lgs. 152/06) and further amendments D1, D15.
Maximum capacity: 250.000 t/y

CONSTRUCTION DETAILS

- Functional improvement, through the construction of earth dam with basaltic rocks and sand and calcarenite gravel (average height 10 m, upper width 6 m, bank slope 33-35°) to achieve safer conditions for entering the dump basin.
- Construction of collecting and pumping systems for leachate/biogas and waterproofing system for basin bottom and slopes with the same features of the works already achieved into the operating landfill basin, according to indications/limitations of the Law Decree No. 36/03.
- Project of providing geocomposite drainage layer with high UV resistance to protect the HDPE liner on the slopes, due to the exposure period of the top edge of the basin.



CONTAMINATED SOIL TREATMENT PLANT IN CATANIA

The combined facility for the contaminated soil treatment combines the advantages of using the process of thermal desorption for the removal of organic contaminants (i.e. hydrocarbons) to those resulting from the use of the inertization process for the stabilization of the inorganic contaminants (i.e. heavy metals).

The thermal desorption system (with a potentiality of 100.000 t/year) is able to treat contaminated soils with operating temperatures below 650°C; it has the following advantages, compared to other traditional systems of incineration of the contaminants: the treatment doesn't have emissions of dioxins and furans; the decontaminated soil still retains the original mechanical properties and it can therefore be used for industrial purposes; the treatment costs are certainly lower.

The inertization system (with a potentiality of 50.000 t/y) is based on the stabilization process - that is used for decades - for the stabilization of hazardous contaminants within a solid compact matrix which is also stable over time. Using the appropriate reagents, cement and water the process also blocks the contaminants that are more dangerous and difficult to treat, such as chromoVI, ammonia, arsenic and mercury.

The facility offers clear advantages in terms of both treatment times (less than those of other traditional systems) and economic, managing to convert hazardous waste into non-hazardous. The soil remediation, which is often too expensive and environmentally costly, is so encouraged.

DESIGN DATA

Private client

E.T.A. SERVICE s.r.l.

Tasks assigned and carried out

Preliminary and final design, Environmental Impact Assessment and Integrated Environmental Authorization application

Estimated cost € 10.170.858,24

Location Catania

UTM Coord. (Zone 33S) 503,250

E - 4,136,770 N

Site area 40.000 m²

Covered surfaces for treatment and storage 11.700 m²

Design period 2013

TECHNICAL DATA

Operations according to Encl. B and C referring to Part IV of Law Decree No. 152/06 (D.Lgs. 152/06) and further amendments D9, D14, D15, R5, R13.

Rain water storage: 160 m³

Leachate storage: 200 m³

THERMAL DESORPTION SECTION

Maximum potentiality: 40 t/h

Type of input waste:

contaminated soils with organic substances (i.e. hydrocarbons)

Average specific electric energy required: 26 kWh/t

Average specific thermal energy required: 540 kWh/t

Air flow: 80.000 m³/h

INERTIZATION SECTION

Maximum potentiality: 14 t/h

Type of input waste:

contaminated soils with inorganic substances (i.e. heavy metals)

Average specific electric energy required: 32 kWh/t

Air flow: 63.000 m³/h

Emission treatment system
Cyclone – Thermal Oxidizer
– Dry scrubber – Baghouses – VOC abatement towers

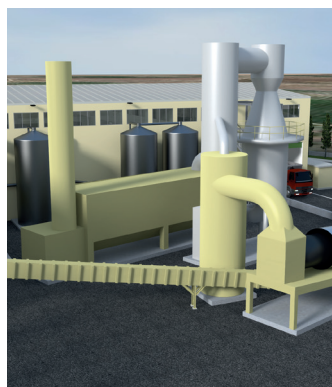
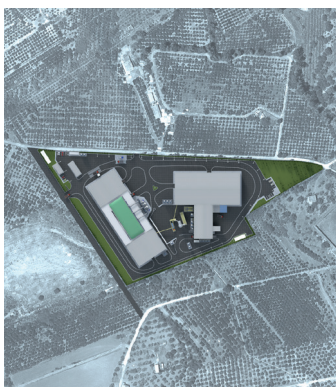



REMEDIATION OF A CONTAMINATED AREA IN AUGUSTA

The site is part of “National Interest Site of Priolo” as identified by Law 426/1998; because of the desire to develop industrial activities in this site in the future, procedures have been started to remediate the contaminated areas for obtaining the release by Environmental Department.

Therefore two environmental characterization investigations were designed and made in order to identify both type and extension of contamination into the soil, the terrain and the groundwater.

108 of boreholes were drilled and over 500 soil samples were collected; chemical analysis of soil samples has revealed a widespread soil contamination by arsenic and a punctual terrain contamination by mercury.

Starting from chemical-physical parameters identified during the site characterization, a site specific assessment was carried out and a non tolerable risk for human health was found both for soil ingestion and dermal contact (industrial use of the site). As result, a site remediation project was designed to remove the state of contamination and enclose the polluted soil in a non-permeable confined basin specifically achieved in a part of the site, thus limiting the handling of excavated materials off site (e.g. landfills).

The underground terrain protection will be ensured by a double non permeable layer of HDPE and a double drainage layer for the leachate collection system (the lower one to detect any possible crack on the upper HDPE layer (according to regulation of Law Decree No. 36/2003 for solid waste landfill, as well as the final cover system, called “capping”).

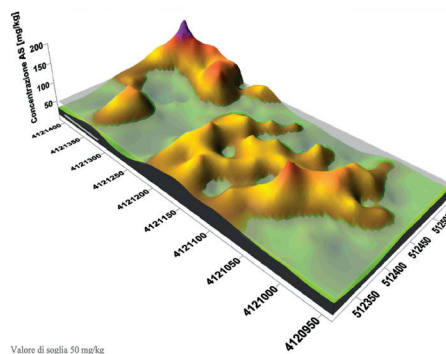

DESIGN DATA

Private client

Joint venture for the management of the environmental hygiene service in Priolo Gargallo S.p.A.

Tasks assigned and carried out

Site characterization, Development of the conceptual site model, Site specific Health Risk Assessment, Final Design

Estimated amount of work

€ 1.063.406,55

Location Augusta (SR)

UTM Coord. (Zone 33S) 512,462

E - 4,121,354 N

Site area 82.000 m²

Estimated contaminated surface 48.600 m²

Total volume of soil to manage 60.000 m³

Design period 2013

TECHNICAL DATA

ACTIVITIES PERFORMED:

Site characterization through the collection of soil and groundwater samples for field and laboratory analysis to determine both type and level of contamination.

Site conceptual model

it was developed through the Characterization Plan results Site Specific Health Risk.

Assessment it was calculated through the site conceptual model in order to determine the Site Specific Target Level for remedial action

Remediation proposal

On-site disposal of the contaminated soils into a non-permeable basin the bottom and walls are adequately waterproofed; the cover system (capping) is composed of a surface layer for vegetation, a drainage layer and a non-permeable layer. The whole project is designed according to regulation of Law Decree No. 36/2003 for solid waste landfill.



COMPOSTING PLANT IN CATANIA

DESIGN DATA

Private client SICULA
TRASPORTI s.r.l.

Typology aerobic stabilization
(composting) into air-forced
lanes

**Tasks assigned and carried
out** Executive design,
Environmental Impact
Assessment, Integrated
Environmental Authorization
application and construction
management

Cost € 10.934.166,45

Location Catania

UTM Coord. (Zone 33S) 505,850
E - 4,137,495 N

Site area 65.900 m²

Plant surface 36.000 m²

Construction period 2010 -
2012

TECHNICAL DATA

**Operations according to Encl.
B and C referring to Part IV
of Law Decree No. 152/06
(D.Lgs. 152/06) and further
amendments** D8, R3, R10.

Maximum capacity: 350.000 t/
year

Number of air-forced lanes:
60 lanes (548 m³ each), among
eight dedicated only to high-
quality composting

Total surface for treatment:
12.800 m²

Type of input material:
undersize resulting from
undifferentiated MSW
screening (producing off-
specification compost) and
organic fraction from separate
collection of MSW (producing
high quality compost)

Average process period: 21÷28
days for off-specification
compost and 90 days for high
quality compost

Rain water storage: 150 m³

Leachate storage: 150 m³

ACCESSORY EQUIPMENT

Air insufflation system: No. 60
centrifugal fans, power 5.5 kW
and flow 6.000 Nm³/h each

The plant operates a biological treatment for stabilizing the organic fraction (also called “undersize resulting from MSW undifferentiated screening”) from the existing MSW mechanical treatment plant. This is aimed at producing off-specification compost. The plant also operates a composting treatment of the organic fraction downstream of the separate collection of MSW. This is aimed at producing high-quality compost. The process of biostabilization occurs within 60 concrete lanes with mobile steel coverage and breathable fabric. The bottom of each lane is provided with a system for the insufflation of the air that is necessary for the process. The air is uniformly distributed through five parallel channels, which extend to the entire length of each composting lane. During the process, temperature, humidity and interstitial oxygen are monitored, and air insufflation is modulated on the basis of these measured parameters. A significant aspect is related to the reduction of emissions into the atmosphere: odorous substances are retained within the lanes by using breathable fabrics. During the oxidation process of the putrescible fraction, the temperature increases due to the degradation activity of the microorganisms, and the evaporation of interstitial water forms a thin film in contact with the cloth itself. Such thin film, together with the small weaving of the cloth (0.2 μm), constitutes a mechanical barrier against the odorous molecules. Smaller molecules (O₂, CO₂, water vapor), instead, are free to transpire. This prevents approximately 95% of the spores and pathogenic bacteria to be spread in the air.

The off-specification compost product can be treated as biomass, and thermally exploited, so as to produce energy that will receive financial incentives when released into the national network.



NON - HAZARDOUS WASTE LANDFILL IN LENTINI

The landfill is included in the non-hazardous waste category in accordance with the Law Decree nr. 36/03 and Law Decree No. 152/06 and further amendments. The buried waste will mainly be constituted by dry fraction deriving from mechanical treatment (screening material), European Waste Code: 191212 and stabilized wet fraction, EWC 190503.

The plant consists of two cells, amounting 1.100.000 m³ and 814.000 m³ of volume respectively. Both cells are waterproofed in order to preserve the environmental matrices in accordance with the Law Decree No. 36/03.

Each cell will be equipped with a double collection system for leachate generated within the landfill, this system counts with a main upper-network for regular leachate accumulation and a secondary lower-network which serves as a backup. Leachate collection pipe network counts with separate sumps where leachate is conveyed by pumps and stored into two separated steel tanks, in order to allow temporary storage before treating the leachate.

Leachate will be treated, within the same landfill site, through a physical-chemical process. The treated effluent within the limits established by the Law Decree No. 152/06 will be discharged into surface-receptors water bodies while the concentrate sludge generated is pumped over the upper landfill section through a specific infiltration system.

The plant is completed by the landfill gas management system for the extraction, collection and upgrading of the biogas generated by the landfill during operation and post-closure periods. This system allows energy recovery by converting biogas in a bio-fuel which can be injected in the natural gas grid and eventually be used as a fuel for the transportation sector. The transformation of bio-wastes into clean energy helps societies to make progress toward becoming circular economies.

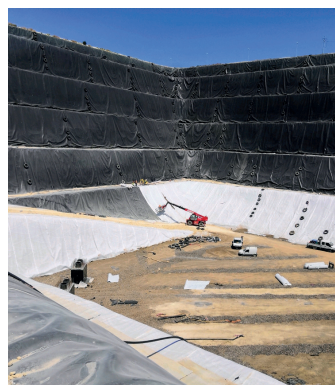

DESIGN DATA

Private client

SICULA TRASPORTI s.r.l.

Tasks assigned and carried out

Final and executive design, Integrated Environmental Authorization application and construction management

Cost € 40.195.425,48

Location Lentini (SR)

UTM Coord. (Zone 33S) 502,790

E - 4,135,670 N

Site area 171.000 m²

Surface of the basins

A 41.800 m²

B 35.500 m²

Total volume 1.914.000 m³

Construction period 2012

TECHNICAL DATA

Operations according to Encl. B and C referring to Part IV of Law Decree No. 152/06 (D.Lgs. 152/06) and further amendments D1, D9, D15.

Maximum potentiality: 350.000 t/year

Expected operating life: 9 years

Days of disposal per year: 320

Maximum production of leachate expected: 50 m³/d

Maximum theoretical biogas production expected: 5÷15 Nm³/waste x y

Accessory equipment: leachate treatment system which provides an ultrafiltration stage and four reverse osmosis stages, with a potentiality of 50 m³/d

Biogas treatment: cogeneration system for the production of electricity

86 vertical wells for biogas collection

one suction sub-station and regulation system

biogas purification system

three Jenbacher engines JGS312 and one emergency torch



REMEDIATION OF EX SNIA - VISCOSA FACILITY IN RIETI

The ex-SNIA Viscosa plant, in Rieti, was built in 1928 as an avant-garde center for the production of artificial fibers in viscose rayon, a yarn which was able to replace various types of fabric, such as silk and cotton, thanks to its versatility. Viscose rayon was largely used to produce both fabrics and knitwear. The factory, however, after various vicissitudes and after an irreversible crisis, ceased production in the early eighties, although some buildings remained active until the end of 2006.

After the cessation of the production some areas of the plant have been “made safe” for the part related to plant sections:

- depletion of plant components from liquids used for the process,
- disconnection of electrical and electronic parts,
- interruption of the paths of transfer of liquids used for the process,
- protection of the storage of hazardous materials, etc.

Part of the site has already been made safe and has been object of remediation for the return of the area to commercial or industrial uses. However, there are still scattered refuse of various kinds (scattered solids and liquids in tanks), as well as plant parts to be divested and dispose or recover. From 2010 to 2013 all the operations necessary for the permanent safety have been carried out in order to avoid possible contaminations of the environmental matrices. In particular asbestos-containing materials were removed and disposed and storage of carbon disulfide (substance used in the production of viscose and highly flammable even at low temperatures) has been emptied, hardened and disposed. Waste disposal overground are still ongoing with the final steps and site-specific risk analysis will be developed, as well and final remediation project.

DESIGN DATA

Private client M.P.S. Leasing & Factoring S.p.A.

Tasks assigned and carried out Design, supervision and safety of works

Amount of work performed € 2.000.000,00

Location Rieti

UTM Coord. (Zone 33S) 323,270
E - 4,697,880 N

Site area 170.000 m²

Built-up areas 39.500 m²

Period of activity 2011 - 2012

TECHNICAL DATA

- Mapping of all overground scattered waste (solid and liquid industrial origin): approximately 800 tons of hazardous waste and about 340 tons of non-hazardous waste.
- Characterization, remediation, transport and disposal of hazardous wastes considered to be highly critical for the environment: about 625 tons.
- Characterization, remediation and disposal of asbestos-containing materials.
- Disposal of carbon disulfide storage used in the productive activities of the factory site and reclamation and decommissioning of the tanks.

ACTIVITIES TO BE CARRIED

Supplementary

- Characterization of the foundation soils of the buildings which have not yet investigated
- Development of the final conceptual model of the site
- Site-specific risk analysis
- Operative remediation project





ENVIRONMENTAL EMERGENCY AND PERMANENT MEASURES IN AUGUSTA

The design was developed in accordance to the need of the Municipality of Augusta to operate the permanent safety measures (according to the Law Decree No. 152/06 and further amendments) for the municipal landfills located in “Ogliastro di Sopra” district. In particular, basins No. 7 and No. 8 have repeatedly caused leachate spilling in the last years, at the same time with heavy rainfalls. This is caused by the lack of the waterproof final capping of the waste and so the rain infiltrates into the waste mass. The lack of adequate storage tanks has also caused these problems because the leachate cannot be pumped and stored during these meteorological events.

The project of the Emergency, Operational and Permanent Safety measures concerns the following topics:

- to isolate the landfill basin by the rainfall;
- to offer the maximum hydraulic safety of the adjacent surface area, through the interception and removal of all the surface rainwater by the construction of drainage canals onto the landfill basins which are linked to the perimetral drainage system; the contour Of the bordering areas (owned by the Municipal Administration too) allows the natural removal of the collected water.

Therefore the purpose of the entire project is to guarantee the environmental protection of soil, surface water and groundwater from any contamination due to the waste mass, interrupting the leak of leachate from the landfill basins and preventing the infiltration of rainwater into the waste mass.



DESIGN DATA

Public client Comune di Augusta (SR)

Tasks assigned and carried out Final design for Emergency and Permanent Safety Measures

Cost € 1.126.317,05

Location Augusta (SR)

UTM Coord. (Zone 33S) 511,274 E - 4,122,395 N

Surface of the landfill basin

basin No. 7 8.000 m²

basin No. 8 10.000 m²

Disposal period

basin No. 7 2001 - 2003

basin No. 8 2006 - 2006

Design period 2012

TECHNICAL DATA

Hydrologic Assessment of the landfill basins' area to calculate the project hydraulic conditions.

Emergency Safety Measures needed to reduce the possibility of leachate load by pumping it away from the collection wells and directing it to authorized plants for disposal. This to safely operate the following remediation steps Re-modeling of the final disposal level so as to give adequate slope to the upper area of the basins.

Supplying of waterproofing layers for the upper covering, through a geomembrane high density polyethylene (HDPE) layer with a thickness of 2 mm (“double rough” type).

Construction of drainage trenches on the summit of the basins in order to control meteoric flows.

Arrangement of vent systems for the biogas trapped under the HDPE layer.

Hydraulic check of the surface drainage sections to avoid the erosion of the designed works.

NON - HAZARDOUS WASTE LANDFILL IN LENTINI

The landfill is included in the non-hazardous waste category in accordance with the Law Decree No. 36/03 and Law Decree No. 152/06 and further amendments. The plant has been designed to receive waste, amounting to about 270 t/d, from neighboring municipalities.

The system consists of a single cell with a volume of 500.000 m³, properly sealed in accordance with the Law Decree No. 36/03 for the aspects regarding the construction of landfills of non-hazardous waste.

The cell is waterproofed in order to preserve the environmental matrices equipped with a double collection system for leachate generated within the landfill, this system counts with a main upper-network for regular leachate accumulation and a secondary lower-network which serves as a backup.

Leachate collection pipe network counts with separate sumps where leachate is conveyed by pumps and stored into two separated steel tanks, in order to allow temporary storage before treating the leachate.

Leachate will be treated, within the same landfill site, through a physical-chemical process. The treated effluent within the limits established by the Law Decree No. 152/06 will be discharged into surface-receptors water bodies while the concentrate sludge generated is pumped over the upper landfill section through a specific infiltration system.

The plant is completed by the landfill gas management system for the extraction, collection and upgrading of the biogas generated by the landfill during operation and post-closure periods. This system allows energy recovery by converting biogas in a bio-fuel which can be injected in the natural gas grid and eventually be used as a fuel for the transportation sector. The transformation of bio-wastes into clean energy helps societies to make progress toward becoming circular economies.

The monitoring of the environmental conditions will be done during the operation and the post-mortem phases according to the Legislative Decree D.Lgs. No. 36/2003.



DESIGN DATA

Private client

SICULA TRASPORTI s.r.l.

Tasks assigned and carried out

Final design, Environmental Impact Study and Integrated Environmental Authorization application

Project cost € 15.515.255,00

Location Lentini (SR)

UTM Coord. (Zone 33S) 502.864

E - 4.135.848 N

Site area 58.000 m²

Surface of the landfill basin
27.000 m²

Total Volume 500.000 m³

Construction period 2011

TECHNICAL DATA

Operations according to Encl. B and C referring to Part IV of Law Decree No. 152/06 (D.Lgs. 152/06) and further amendments D1, D15.

Maximum potentiality: 90.000 t/year

Expected operating life: 5 years

Days of disposal per year: 320

Maximum production of leachate expected: 11 m³/d

Maximum theoretical biogas production expected: 5÷15 Nm³/t_{waste} x y

ACCESSORY EQUIPMENT

Leachate treatment system that includes stages of ultrafiltration and a final stage of reverse osmosis, with a potentiality of 1.5 m³/h

Biogas section system:

11 vertical wells for biogas collection,

11 secondary supply lines, one main feed line,

one suction and regulation substation.

Energy recovery system: existing system within the industrial district

M.S.W. TREATMENT INTEGRATED SYSTEM IN PARTINICO

In order to operate an integrated management of municipal waste the designed plant allows to:

- i) pre-treat the incoming waste (shredding);
- ii) select the dry fraction, the wet fraction (underscreen), and recyclable fractions (metals, plastics, glass, etc.);
- iii) perform a post-treatment of the organic fraction through biological (anaerobic and aerobic) processes; iv) produce high-quality compost to be used as fertilizer in common agricultural practices; v) produce high-calorific-value material (RDF), which can be used as fuel in cement factories or thermal power plants; vi) produce electricity and thermal energy in order to balance out part or total self-consumption.

The potentiality is 100.000 t/y of unsorted municipal waste and 30.000 t/y of separate collected organic waste for producing high-quality compost; the designed process lines are: one line for the mechanical treatment of undifferentiated MSW (shredding, screening, metal separation, RDF fine-shredding); one section for the anaerobic digestion of the underscreen fraction (within 14 heated concrete tunnels); one section for the stabilization and aerobic biological drying of the digestate (in aerated heaps within eight tunnel); one line for the production of high-quality compost (including pre-treatment section, eight aerobic stabilization tunnels and one maturation and refining section); one cogenerator for producing electrical and thermal energy from the biogas produced by the anaerobic digestion; one K.W.G. module (consisting in a containerized thermal unit), which exploits the molecular dissociation process; this module produces electricity from waste material and a vitrified residue, which can be reused for civil purposes such road and railway foundations, etc.

DESIGN DATA

Location Partinico (PA)
UTM Coord. (Zone 33S) 330.844
 E - 4.206.205 N
Site area 72.000 m²
Plant surface 56.000 m²
Treatment area 18.100 m²
Roads and auxiliary services area 32.000 m²
Design level preliminary design
Design period 2014
Tasks assigned and carried out
 Preliminary design
Cost € 41.284.257,35

TECHNICAL DATA

Operations according to Encl. B and C referring to Part IV of Law Decree No. 152/06 (D.Lgs. 152/06) and further amendments D8, D9, D14, D15, R1, R3, R4, R5, R10, R13.
Treatment capacity: 100.000 t/y of M.S.W.;
 30.000 t/y of organic waste from separate collection and pruning waste from gardens and parks
Treatment and recovery lines:
 one M.S.W. mechanical-biological treatment
 one mechanical-biological organic waste treatment
 one section for energy production from biogas and waste from the selection
Working days per year: 312
Employable personnel: 20

ACCESSORY EQUIPMENT

Air treatment: 170.000 Nm³/h
Air treatment system: wet scrubbers and biofilters
Biofilter surface: 1.000 m²
Biogas cogeneration system:
 flow 10.000 m³/d, power 800 kWe - 810 kWt
Waste exploitation system:
 flow 15 m³/d, power 800 kWe - 810 kWt





PHOTOVOLTAIC PLANT

(POWER 995.72 KW)

NAPOLI

The plant is a grid-connected system, which is located on the roof of the hangar no. 1 of the International Airport Capodichino in Naples, in the Municipality of Casoria; after the cleaning and the waterproofing of the roof (pitched on a slight slope) 4.526 panels (Innova Solar TEM 220P models with a nominal power of 220 W each) were installed on steel rail supports. The power of the entire system is therefore equal to 995.72 kW, with an average production around 1.2 GWh/y.

The installation of the photovoltaic power plant was only possible after a period of experimentation carried out in collaboration with the Department of Technical Physics of the University of Palermo, in order to evaluate the potential degree of glare against aircraft during takeoff, landing and circling. The results of the tests performed have led to selection and installation of modules whose protective crystal has an internal roughness to reduce any phenomenon of reflection of incident sunlight. Photovoltaic modules are connected to the national distribution network in three-phase medium voltage; two generators Copernicus TL-SF-200 Astrid model and two generators Copernicus TL-SF-250 Astrid model were installed, in order to ensure a maximum power of 1 MW.

The installation and proper management of the photovoltaic allow big savings on traditional fuels and a reduction in emissions of greenhouse gases. The savings in terms of fossil fuels could be estimated in about 230 TOE (tons of oil equivalent) per year, while a reduction in greenhouse gas emissions of approximately 620 tons of CO₂ each year was calculated.

DESIGN DATA

Private client

New Energy S.p.A.

Tasks assigned and carried out

Final design, construction management and safety coordination

Total cost € 3.350.000,00

Location International Airport Capodichino (NA)

UTM Coord. (Zone 33S) 441,345 E - 4,526,640 N

Area of intervention 15.000 m²

Commissioning and start-up 2011

Construction period May - December 2010

TECHNICAL DATA

System type: Partially integrated

Type of PV modules:

Polycrystalline silicon modules

Number of installed panels: 4.526

Occupied area: about 7.700 m²

Rated power of the individual panel: 220 Wp

Total installed power: 995.72 kWp

Average annual energy produced: 1.2 GWh

4 three-phase inverter, 900 kW total (2 x 200 kW + 2 x 250 kW)

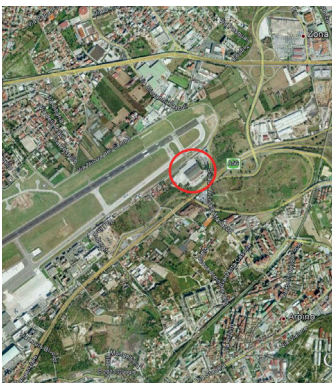

ORGANIC WASTE GASIFICATION PLANT IN CATANIA

The plant design will permit the enlargement of the existing M.S.W. mechanical screening by adding an organic waste gasification unit. The design abides by the obligations set forth by the Italian Decree that regulates environmental integrated authorizations (D.R.S. 248 of 26/03/2009), in order for the already-existing plant to maintain the previously-obtained authorization. The system is designed in a four-line plant, with each line processing a nominal 6 t/h of special non-hazardous waste resulting from MSW mechanical-biological treatment. The furnaces for each of the four lines will have two separate chambers: one for the gasification (primary) and one for the oxidation (secondary); each chamber will be arranged in a 'single-box' type configuration. The produced Syngas will be provided to four heat recovery steam generators (HRSG), each of which will produce 16.4 MW of thermal output in the form of superheated steam at 23 bar (absolute) and 380°C. The steam from the boilers will be supplied to a single Steam Turbine which shall nominally generate 16.5 MW of electricity. The steam from the turbine will exhaust into an air-cooled condenser, which will normally operate at a pressure of 0.1 mbar absolute. Each gasification line is equipped with a bag house filter, located downstream the HRSG; the filter operation is based on the injection into the flue-gas of lime and carbon for absorbing acid components, heavy metals, mercury, TOC and dioxins. The plant is also equipped with a control and monitoring system, which performs an automatic control of the process and the emissions from the stack. Each process line is equipped with a main control PLC and an additional PLC that serves the common equipment. All process control and monitoring computers and PLCs are powered via an uninterruptible power supply (UPS) which has a nominal thirty minute capacity.

DESIGN DATA

Location Catania
UTM Coord. (Zone 33S) 505.220
 E - 4.137.596 N
Site area 9.00 ha
Built shed surface 11.000 m²
Designed shed surface 8.000 m²
Design level the facility is authorized according to the Italian decree that regulates Integrated Environmental Authorizations (D.R.S. No. 248 of 26 March 2009)
Design period: 2011
Tasks assigned and carried out Final design
Estimated Cost € 76.300.00,00

TECHNICAL DATA

Operations according to Encl. B and C referring to Part IV of Law Decree No. 152/06 (D.Lgs. 152/06) and further amendments D10, R1.
Estimated capacity: 200.000 t/y - 24 t/h
Inlet waste: non hazardous waste from mechanical screening and biological treatment by the built system
Treatment lines:
 No. 4 gasification lines (primary chamber) and No. 4 oxidation chambers
 No. 4 boilers (HRSG)
 No. 1 steam turbine
 No. 1 air cooled condenser for exhaust steam

ACCESSORY EQUIPMENT

Flue gas treatment: n. 4 baghouses (one for each line), n. 2 line and carbon silos and n. 2 filter dust silos.
 Control and monitoring system (a main PLC for each process line and an additional PLC for common equipment).
 Emission measurement and control system (one for each line).

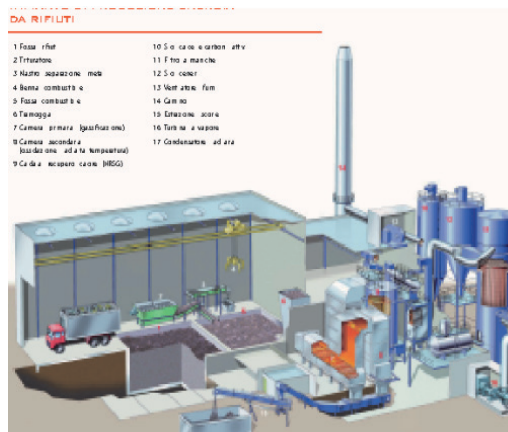



PHOTOVOLTAIC PLANT (POWER: 414 KW) IN CATANIA

The plant is a grid-connected system, and is located on the roof of an industrial building used for the treatment of municipal solid waste in Catania; after having designed and manufactured the specific steel structures of support to adapt to the type of coverage of the industrial building, 1.800 panels (InnovoSolar MET 230P models with a nominal power of 230 W each) were installed on special steel rails anchored to the above structures. The power of the entire system is therefore equal to 414.0 kWp, with an average energy production of about 642.000 kWh/y.

The installation of the photovoltaic power plant was only possible after a period of static verification carried out in collaboration with the manufacturer of prefabricated shed, to assess the maximum allowable overload above the roof.

The photovoltaic system is connected to the local distribution network at a voltage of 20 kV; two inverters (Friem Recon 330 model) were installed, in order to ensure a maximum 0.6 MW power.

The installation and proper management of the photovoltaic system allow big savings on traditional fuels and a reduction in emissions of greenhouse gases. The savings in terms of fossil fuels could be estimated in about 110 TOE (tons of oil equivalent) per year, while a reduction in greenhouse gas emissions of approximately 300 tons of CO₂ each year was calculated.

DESIGN DATA

Private client

SICULA TRASPORTI s.r.l.

Tasks assigned and carried out

Final design, construction management and safety coordination

Total cost € 1.650.000,00

Location C.da Codavolpe, Vaccarizzo Area - Catania (CT)

UTM Coord. (Zone 33S) 505,376 E - 4,137,774 N

Area of intervention 10.500 m²

Construction period June - December 2010

Commissioning and start-up 2011

TECHNICAL DATA

System type: On building - Not integrated

Type of PV modules:

Polycrystalline silicon modules

Number of installed panels:

1.800

Occupied area: about 2.970 m²

Rated power of the individual panel: 230 Wp

Total installed power: 414.00 kWp

Average annual energy

produced: 641.7 MWh

Inverters installed: two three-

phase inverters, 600 kW total





M.S.W. MECHANICAL TREATMENT PLANT IN CATANIA

The pre-selection plant of mixed waste is divided into four parallel lines, each of which comprises a pre-selection stage consisting of a coarse shredding, a primary screening, a separation of ferrous and non-ferrous metals and a pressing of the coarse material, and a refining step of the organic waste consisting of a secondary screening, with the production of an underscreen to be biologically stabilized and an overscreen to be processed with ballistic and infrared separation of recyclable materials. The system doesn't require the use of personnel for the sorting operations, which are conducted exclusively automatical and managed by an operator from the control room. From the undifferentiated M.S.W. the process allows the separation of the following: plastics to be recycled; iron and aluminum to be later in foundries; organic material to be stabilized for covering landfills or environmental remediation; material with high calorific value and pressed into bales for disposal in landfill or for recovery as fuel in incinerators.

The factory shed is constantly kept under negative pressure in order to ensure the health of the workplace. The air treatment system is constituted by a scrubber (washing tower type) and a biofilter capable of returning the air in the atmosphere in accordance with the most stringent levels set forth by law.

An implementation phase is also in place, which is aimed at the refining of the screening material coming from the primary and secondary screening and waste of the ballistic and optical separation; this material is the so-called RDF (Refuse Derived Fuel), a "product" that will be inserted in the chain of the fuels used in cement plants, power electrical stations, etc.



DESIGN DATA

Private client

SICULA TRASPORTI s.r.l.

Tasks assigned and carried out

Executive design and construction management

Cost € 27.437.210,46

Location Catania

UTM Coord. (Zone 33S) 505,315 E - 4,137,580 N

Site area 90.000 m²

Shed surface 11.000 m²

Construction period January 2009 - December 2010

Shed in prestressed concrete with shingle roofing in prestressed concrete

TECHNICAL DATA

Operations according to Encl. B and C referring to Part IV of Law Decree No. 152/06 (D.Lgs. 152/06) and further amendments D9, D14, D15, R3, R4, R5, R13.

Maximum capacity: 220 t/h

Treatment lines: 4

Sections: Primary shredding - Primary screening to 200 mm - Separation of ferrous and non-ferrous metals - Secondary screening at 80 mm - ballistic and optical separation of plastics - Baling of plastics - Baling of the screened material to be sent to landfill

Rain water storage: 100 m³

Leachate storage: 270 m³

ACCESSORY EQUIPMENT

Air treatment: 270.000 Nm³/h

Air treatment system: wet scrubbers and biofilters

Biofilters surface: 1.900 m²

Photovoltaic system on the roof: 414 kWp consisting of 1.800 PV panels of 230 Wp each

Average annual electricity production: 650 MWh



SEWAGE TREATMENT PLANT IN CATANIA

The plant is placed within a very strategic area because it's near the port of Catania, well served by the railway tracks. The platform is designed to treat both oily emulsions and the so-called bilge water that may come from the nearby port area of Catania. The system can also treat hazardous and non-hazardous liquid waste from the industrial centers of eastern Sicily (e. g. Priolo Gargallo, Siracusa, Gela, etc.).

The plant architecture provides the possibility to treat wastewater of different nature on separate lines. A first slurry line will be devoted to the treatment of sewage with a high organic load (such as the food industry waste and the spoils of septic tanks), for which an initial solids separation by grill and a physical - chemical pretreatment in clariflocculator are provided. A second process line will be dedicated to acidic and alkaline wastewater, for which a preliminary neutralization and the physical-chemical treatment in clariflocculator are provided. Finally, A third line slurry will be suited for the treatment of liquid waste with a high content of oily emulsions, bilge water and so called "recalcitrant" waste (such as surfactants) and a sedimentation with intercepting of oil and a preliminary oxidation with Fenton reagent are provided. After the different stages of pre-treatment, all the sewage lines are equalized and subjected to biological treatment with activated sludge. Subsequent steps of denitrification and final sedimentation are then provided. Finally, the tertiary treatments provide a filtration with sand and activated carbon and a final UV disinfection. The sludge line is constituted by a mechanical dewatering for the chemical-physical sludge and a thickening followed by aerobic stabilization and mechanical dehydration for the biological one. All plant sections are equipped with air suction devices in order to reduce VOC emissions.

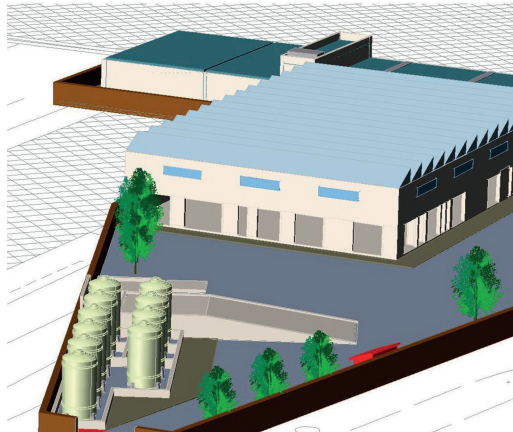
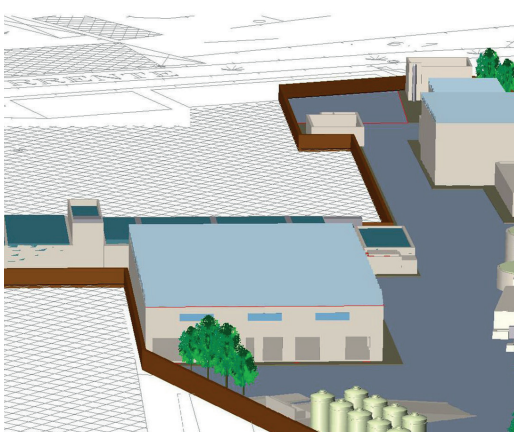

DESIGN DATA

Private client

WISCO s.p.a.

Tasks assigned and carried out

Final and executive design, Environmental Impact Assessment and Integrated Environmental Authorization application

Cost € 6.150.772,56

Location Catania

UTM Coord. (Zone 33S) 506,715

E - 4,148,950 N

Site area 11.000 m²

Design period 2010

TECHNICAL DATA

Operations according to Encl. B and C referring to Part IV of Law Decree No. 152/06 (D.Lgs. 152/06) and further amendments D8, D9, D15.

Maximum potential: 225.000 m³/y; 750 m³/d

Working days per year: 350

Treatment sections:

preliminary solid separation with grill

acidic and alkaline waste neutralization

Sand and oil separation

Biological treatment with activated sludge with denitrification section

final sedimentation

UV disinfection

sludge line: thickening, aerobic biostabilization and mechanical dehydration.

ACCESSORY EQUIPMENT

Air treatment: fan system and air treatment from plant

Section with higher production of odorous substances: 45.000 Nm³/h

Biofilter surface: 400 m²



SEWAGE TREATMENT PLANT IN AUGUSTA

The plant is part of the Industrial Development Area of Siracusa-Augusta and, therefore, easily reached via the road network of the I.D.A., well connected to the highway Catania-Gela.

The platform is designed to treat organic, urban or agribusiness liquid waste and industrial liquid waste (mostly from the poles of Eastern Sicily), such as leachate, galvanic and photographic water, etc.

The plant architecture provides the ability to treat wastewater of a different kind on separate lines: the first, indeed will be dedicated to the treatment of sewage with a high organic load (such as waste of the food industry and the spoils of septic tanks), for which there are provided a screening and initial grit removal and a second process line, which will be dedicated to industrial wastewater, for which there is provided a pre-treatment of chemical-physical type.

After the pre-treatment steps, both sewage lines are equalized and subjected to membrane biological remediation (MBR) with subsequent denitrification; traditional sedimentation is replaced with a reverse osmosis (R.O.) treatment with final evaporation-crystallization. The sludge line, finally, consists of a dehydration-type centrifuge for both chemical and biological sludge, after stabilization with a dosage of polyelectrolytes to improve the power of dehydration.

All plant sections are equipped with air intake systems in order to limit the emissions of VOCs in the atmosphere, the air drawn in is treated through the passage within a biomass filter biofilter, sized for a flow of about 3.000 Nm³/h.

DESIGN DATA

Private client

STTA s.r.l

Tasks assigned and carried out

Final design, Environmental Impact Assessment and Integrated Environmental Authorization application

Cost € 2.971.758,33

Location Augusta (SR)

UTM Coord. (Zone 33S) 515,050

E - 4,116,870 N

Plant area 6.500 m²

Design period 2010

TECHNICAL DATA

Operations according to Encl. B and C referring to Part IV of Law Decree No. 152/06 (D.Lgs. 152/06) and further amendments D8, D9, D15.

Maximum potential: 32.000 m³/y; 100 m³/d

Working days per year: 350

Treatment sections:

preliminary solid separation with grill

Sand and oil separation

Physical-chemical pretreatment

MBR biological treatment

with a denitrification and

ultrafiltration section

reverse osmosis treatment

evaporator

final dehydration of sludge

ACCESSORY EQUIPMENT

Air treatment: fan system

and air treatment from plant

Section with higher production

of odorous substances: 3.000

Nm³/h

Biofilter surface: 33 m²

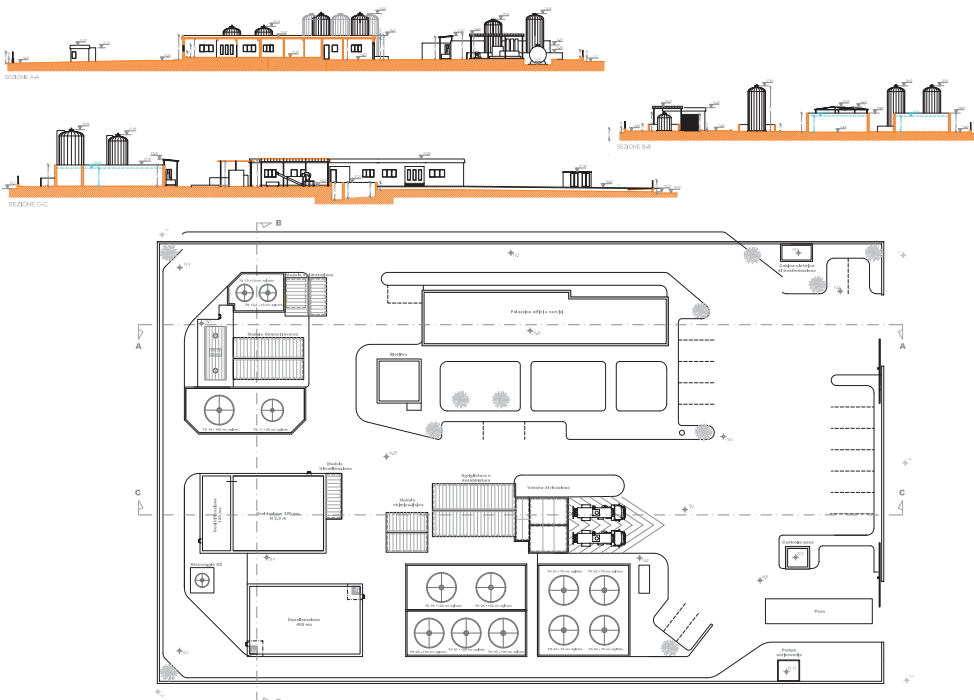



NON - HAZARDOUS WASTE LANDFILL IN AUGUSTA

The landfill is located within the industrial area of Augusta and receives waste generated by the Municipality of Priolo and Garallo and neighbouring towns reducing costs and improving previous waste management solutions. The design provides the construction of a landfill situated in an area of about 83.000 m², with a disposal capacity of 660.000 m³ serving about 175.000 citizens for 6 years.

Each cell will be waterproofed in order to preserve the environmental matrices equipped with a double collection system for leachate generated within the landfill, this system counts with a main upper-network for regular leachate accumulation and a secondary lower-network which serves as a backup. Leachate collection pipe network counts with separate sumps where leachate is conveyed by pumping it into two separated steel tanks, in order to allow separately temporary storage before periodical transportation to final disposal authorised plants.

The plant is completed by the landfill gas management system for the extraction, collection and upgrading of the biogas generated by the landfill during operation and post-closure periods. This system allows energy recovery by converting biogas in a bio-fuel which can be injected in the natural gas grid and eventually be used as a fuel for the transportation sector. The transformation of bio-wastes into clean energy helps societies to make progress toward becoming circular economies.

The monitoring of the environmental conditions will be done during the operation and the post-mortem phases according to the Legislative Decree D.Lgs. No. 36/2003.

DESIGN DATA

Private client

Joint venture for the management of the environmental hygiene service in Priolo Gargallo S.p.A.

Tasks assigned and carried out

Final design, Environmental Impact Assessment and Integrated Environmental Authorization application

Cost € 8.846.356,46

Location Augusta (SR)

UTM Coord. (Zone 33S) 512,458

E - 4,121,347 N

Site area 83.000 m²

Surface of the landfill basin

45.200 m²

Total volume 660.000 m³

Designing period 2008

TECHNICAL DATA

Operations according to Encl. B and C referring to Part IV of Law Decree No. 152/06 (D.Lgs. 152/06) and further amendments: D1, D15.

Maximum potentiality: 98.000 t/year

Expected operating life:

6 years

Maximum production of leachate expected: 9 m³/d

Maximum theoretical biogas production expected: 1.068

Nm³/h

ACCESSORY EQUIPMENT

Biogas suction system:

36 vertical wells for biogas collection

36 secondary supply lines

three main feed lines

three regulation substations

one suction substation

Energy recovery system:

three internal combustion engine,

600 kW each

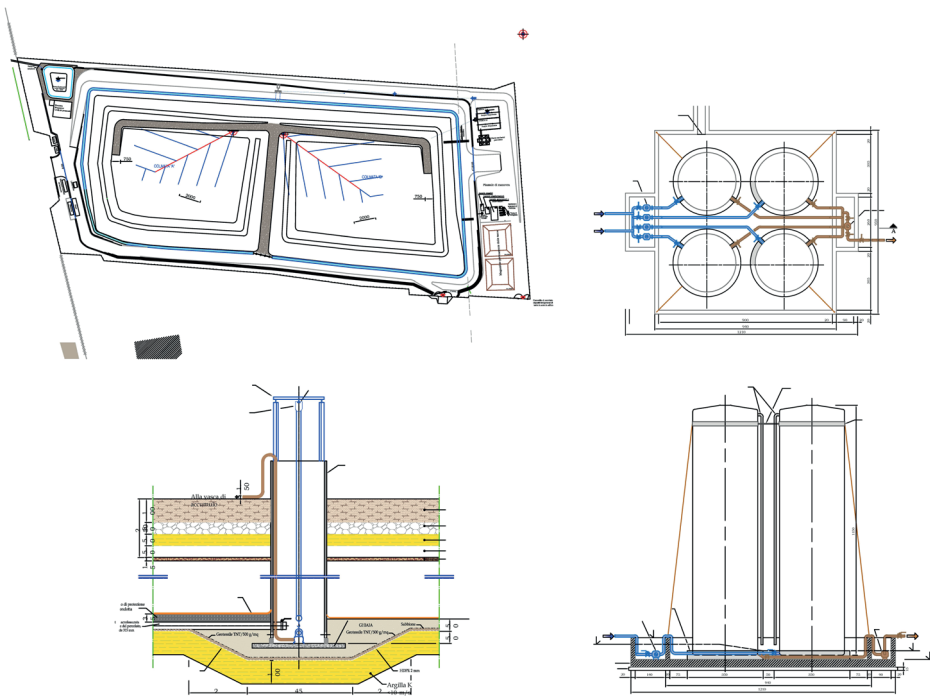



ASBESTOS - CONTAINING WASTE LANDFILL IN LENTINI

The system is configured as a strategic work in the integrated management of waste in order to reduce the disposal costs of Asbestos Containing Materials and it falls under the category of landfills for the transfer of hazardous waste, in accordance with D.Lgs. No. 36/03 and D.Lgs. No. 152/06 and further amendments. The main type of incoming waste will be constituted by asbestos-containing materials from remediation sites of these materials (EWC codes planned: 06 07 01*, 06 13 04*, 10 13 09*, 10 13 10, 15 01 11*, 16 02 12*, 17 06 01, 17 06 05*, 19 03 04*, 19 03 06).

The plant has been designed in such a way as to allow a waste management conferred in separate cells on the basis of the typology and the dangerousness of the same material; in total were provided five cells managed separately and independently from each other for a total volume of approximately 500.000 m³ available. Particular attention has been taken in the design of the waterproofing layer at the bottom and on the walls, in order to avoid any possibility of leaching of pollutants into the ground water; placed materials (carefully sealed) will be daily covered with inert material in order to avoid any possible air dispersion of fibers or waste.

On the bottom of the landfill has been arranged a double network for the uptake of the leachate from the waste delivered, the first for the ordinary drainage and the second, the lower one, for the safety drainage. The networks of leachate converge to two separate wells of the collection and recovery, in order to allow temporary storage of leachate within separate and dedicated units; leachate is then pumped to the treatment plant, from which is obtained a clarified effluent (compatible with the limits established by D.Lgs. No. 152/06 and further amendments, for discharges into the surface water bodies receptors).

DESIGN DATA

Private client

SICULA TRASPORTI s.r.l.

Tasks assigned and carried out

Final design, Environmental Impact Assessment and Integrated Environmental Authorization application

Cost € 20.253.775,00

Location Lentini (SR)

UTM Coord. (Zone 33S) 502,790

E - 4,135,950 N

Site area 35.000 m²

Surface of the landfill basin
27.000 m²

Total Volume 500.000 m³
divided into five lots

Design level final design

Design period 2008

TECHNICAL DATA

Operations according to Encl. B and C referring to Part IV of Law Decree No. 152/06 (D.Lgs. 152/06) and further amendments D1, D9, D15.

Potentiality: 40.000 t/year

Expected operating life: 7 years

Days of disposal per year: 350

Maximum production of leachate expected: 10 m³/d

Maximum theoretical biogas production expected: according to the non-biodegradable nature of asbestos-containing materials, any biogas production is not expected.

ACCESSORY EQUIPMENT

Leachate treatment system: ultrafiltration system divided into a safety conditioning section, a treatment section and a washing section of the membranes. The treatment capacity is approximately 12 m³/d

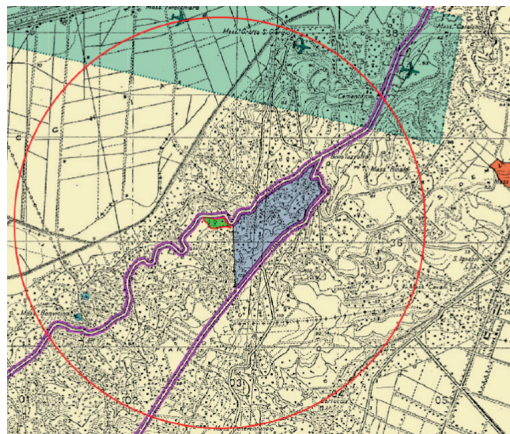

MOTOR VEHICLES DEMOLITION CENTER

The system is configured as a center for the remediation and the safety recovery of materials and the scrapping of motor vehicles and trailers and for the retention and the recovery of Waste Electrical and Electronic Equipment (WEEE) ensuring an integrated waste management in order to minimize the impact on the environment and to recover all the materials and energy as possible.

The plant has been designed in accordance with the “regional plan for the area of collection centers for the safety, demolition, material recovery and destruction of motor vehicles and trailers”, for the treatment of approximately 1.500 vehicles per year. It may also receive, for storage and later retrieval, a quantity of WEEE of about 1.100 t/year. The industrial site covers an area of approximately 4.900 m² and consists of two main sections: the first is intended to motor vehicles out of order and the second to the storage of WEEE; the motor vehicles scrapping area, of about 3.600 m², consists of two main open areas for the storage of the vehicles incoming and outgoing (destined to pressing/crushing) and a shed in which all the dismantling operations, storage and retrieval of motor vehicles out of order are carried out.

The storage area of WEEE, of approximately 1.300 m², is instead made up of a single building, in which the incoming WEEE and parts/hazardous waste are stored and where reusable components are disassembled and stored.

Particular attention has been paid to the design of networks of separate waste water (industrial water, rain water and civil wastewater), in order to preserve the environmental matrices involved (soil, subsoil and underground water).

DESIGN DATA

Tasks assigned and carried out

Final design, Environmental Impact Assessment and Integrated Environmental Authorization application

Amount of work € 1.120.951,54

Location Catenanuova (EN)
UTM Coord. (Zone 33S): 471,770
E - 4,157,660 N

Site area 7.800 m²

Treatment area 4.900 m²

Scrapping vehicles area 3.600 m²

WEEE storage area 1.300 m²

Covered areas 1.560 m²

Design period 2008

TECHNICAL DATA

Operations according to Encl. B and C referring to Part IV of Law Decree No. 152/06 (D.Lgs. 152/06) and further amendments R13.

Treatment potentiality:

1.500 vehicles/year

1.100 t/y of WEEE

Expected working days per year: 350

Incoming vehicles storage area: 340 m²

WEEE storage area: 670 m²

Waste oil storage capacity: 500 l

Leachate storage: 150 m³

Rain water storage: 60 m³

ACCESSORY EQUIPMENT

Fixed installation of detection and extinguishing fires constituted by a distribution ring equipped with one UNI70 hydrant and five UNI45 hydrants within the buildings
Mobile systems shutdown: 50 kg wheeled fire extinguishers and 6 kg portable

WIND FIELD (POWER 26.65 KW)

The plant for the production of energy from renewable sources (wind energy) was carried out in the Municipality of Alberona, in the locality of Toppo Seggio - Coppe di Mezzanelle, at an altitude ranging between 280 and 400 m above sea level, along the ridge of the hills. The plant consists of a total of 13 wind turbines with a rated power of 2,05 MW each, for a total nominal power of 26,65 MW.

The installed wind turbines are all Enercon brand, model E82 and are therefore characterized by a nominal power of 2.050 kW and variable rotation speed from 6 to 17.5 rpm (for smaller or larger values of wind speed the generator stops by an automatic device to avoid mechanical damage). The rotor has a diameter of 82 m, it is mounted on a hub of about 85 m high and each wind turbine is equipped with three fiberglass blades (with embedded lightning rod), each of which is equipped with an adjustment system with independent emergency power, holding brake rotor and the rotor block. The engine type is direct drive synchronous ring and the noise level of each wind turbine reaches about 41-45 dB(A) at a distance of 300 m. Each turbine has a floor space of a few tens of square meters since, after the construction phase in which the bulk medium was equal to 800 m², all the surrounding areas have been subjected to a renaturation, in order to minimize the impact done on the ground. For the same purpose, only existing traffic routes have been used, consolidating with ecological material stabilized very similar to the natural ground parts that needed surgery. The foundations of the wind turbines are plinth of the circular section direct type with a diameter of 14.7 m. The energy produced is piped through underground electrical cables, to the point of delivery Enel located within the same wind farm.

DESIGN DATA

Location Alberona (FG)
UTM Coord. (Zone 33S) 517,480
 E - 4,591,220 N
Area of intervention about 9 ha
Construction period September 2006 - December 2008
Commissioning and start-up 2009
Tasks assigned and carried out High monitoring to the implementation
Total cost € 39.800.000,00

TECHNICAL DATA

Wind turbine generators
Rated power: 2.050 kW
Rotor diameter: 82 m
Hub height: 85 m
Number of turbines: 13
Total installed power: 25,65 MW
Average annual production capacity: 50÷60 GWh
ROTORS
Type: Upwind rotor with blade active control
Direction of rotation: clockwise
Rotation speed: 6÷17.5 rpm
Number of blades: 3
Described area: 5.281 m²
Blade adjustment: independent control system for each blade with emergency power, holding brake rotor, rotor block
Transmission with generator
Generator: direct drive ring
Grid feeding: inverter
Wind speed retainer: 28÷34 m/s with storm control



FACTURED CLAY: THEME PARK OF THE “TARGA FLORIO”

The project in response to the announcement, addressed the themes:

- the redevelopment and enhancement of the environmental and landscape areas with the construction of a museum, an auditorium, outdoor spaces, a safe driving track;
- how to access the area;
- the upgrading of the SS 113 and 120 in the sections concerned;
- the conservative recovery and the reduntionalization of the architectural complex of the Targa Florio.

The context of Floriopoli is characterized by mainly hilly morphology with dominant clayey constitution. The predominant lithological formation is that of the clayey complex. The goal of the project is to include the new buildings in a discrete system that reinforces the overall image of the pre-existing settlement.

The strategies implemented are: the remodeling of the soil upstream of the road layout near historic buildings, inserting the new functions (museum and auditorium) inside semi-hypogeal spaces. The intervention is delimited, on the road front by a line of “offser” of ten meters along which are generated tensions of different nature (pre-existences, geometries) that determine four points of fracture in the ground that determine the design choices.

DESIGN DATA

Private client PROVINCIA REGIONALE of PALERMO
Type of service Definitive planning
Total amount € 40.000.000,00
Location Municipality of Termini Imerese (PA)
Surface of the lot 140.000 square meters
Design period 2012
Top 2 selected

TECHNICAL DATA

Design director and supervision: Francesco Briguglia
Architects: Francesco Cucchiara, Luca Grammautaa, Alberto Giambruno
Team: Intertecno s.p.a., Studio Scibilia s.r.l.



CREDITS





OMAN PAVILLION AT EXPO MILANO 2015

The Sultanate of Oman signed the participation contract of Expo Milano 2015, the next Universal Exposition, to be held in Milan, Italy, from May 1st to October 31st 2015, and which will focus on the theme "Feeding the planet, energy for life".

For this purpose, Oman has reserved a space of 2,790 m² and its pavilion will be built in a strategic position within the exhibition site, in front of one of the main entrances of the Expo venue. Now, the Ministry of Foreign Affairs of the Sultanate of Oman invited specialized companies for competition to bid for the project of Designing, Constructing, Furnishing, Outfitting, Demolishing, Removing and Disposing the Materials of Sultanate of Oman Pavilion at Expo Milano 2015. The joint venture of companies and designers has been purposely assembled for tendering for the Oman Pavilion at Expo Milan 2015, with the aim of creating a unique offer in terms of skills, know how, knowledge and creativity. The lot dedicated to the Omani Pavilion is located in proximity to the secondary entrance which is easily reachable from the parking lot located on the east side of the Expo. The Omani Pavilion's location has many advantageous aspects: the lot has the good fortune not to have neighbors lots on both sides and is adjoining with a green area with trees.

DESIGN DATA

Private client

OMAN - MINISTRY OF FOREIGN AFFAIRS

Type Pavilion Expo 2015 Milan

Cost \$ 11.000.000,00

Location Milano Italy

Area 2.790 m²

Design level Final Project

Design period 2013-2014

Top 3 selected

TECHNICAL DATA

International Team: Sering International, Al Nhadha, Coveco, Italiana Costruzioni

Design Team: Squar-e Architettura + Francesco Librizzi studio

Design supervision: Francesca Arici

Design director: Francesco Librizzi

Curator: Luca Molinari

Graphic design: Andrea Puppa

Local coordinator: Francesca Mollica

Team of experts: Zahir Bin Khalid Al Sulaimani, Khair Tuwair Said Al Busadi, Saif Ali Salim Al-Khamisi, Saif Bin Khamis Al Rawahi, Prof. Robert Blake, Dr. Francesco Pinelli

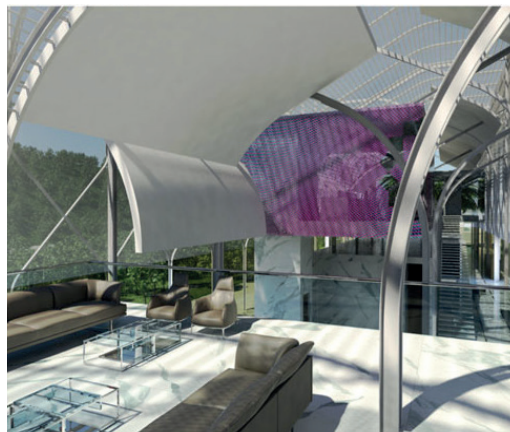

CREDITS



MILANO 2015



LE VIE DELL'ACQUA: STRATEGIC MASTERPLAN OF THE CITY OF ABANO AND MOTEGROTTO TERME (PD)

The objective plan is to elevate, increase and differentiate receptive offer and available services.

Therefore, a new Architectural and Landscape system is opened able to appear as an innovative settlement system and reference for the individuated offer typology.

The water is the territory characteristic element, it becomes the landscape key of the entire intervention. Its availability and specify quality are offered, to new Architectural scenarios which allows to renew and throw in the future, a unique territory of landscape and therapeutic quality.

In this way, it is possible to make a series of high quality hotels and new areas growth.

The system is composed by three interconnected fundamental parts and they can be developed in several stages

- Phase 1a: HdB + HdN integration in a single management structure
- Phase 1b: Resorts realization
- Phase 1c: Several structures and landscape system
- Phase 2: Grand Hotel Orologio renovation and nearly park
- Phase 3: Hotel Magnolia, Hotel Montecarlo, Hotel Caesar Terme renovation and re-use.

DESIGN DATA

Location Abano e Montegrotto Terme (PD) Italy
Type Masterplan
Designing period 2014
Tasks assigned and carried out
 Final project
Cost € 188.555.413,11
Cost detail
 - Grand Hotel Orologio
 € 38.401.110,00
 - Hotel Magnolia
 € 14.521.290,54
 - Hotel Caesar Terme
 € 11.292.821,33
 - Hotel De Bains
 € 11.614.667,77
 - Hotel Terme Montecarlo
 € 9.197.191,73
 - Grand Hotel Terme delle Nazioni € 14.614.667,77
 - Resort Termale
 € 21.208.585,19
 - Residence termale
 € 67.711.078,78



TECHNICAL DATA

Squar-e Architettura
 (Francesco Briguglia, Giuseppae Di Prima Architetti) + Francesco Librizzi studio



MOSAICOON S.P.A. HEADQUARTER

A 4,000 square meters seafront open space with swings, billiards, sofas and citrus trees; the best of tech companies of Silicon Valley would be envious of such an office set among the breath-taking sunset of one of the most beautiful gulfs of Sicily and signature of the best excellence of Italian design: Mosaicoon, the leading Sicilian Tech Company in video production and web distribution, opens its new Headquarters in Isola delle Femmine in Palermo.

The employees themselves decide whether to work in an open space or to create borders for individual teams thanks to smart panels which can open or close depending on one's needs.

With a feel at home environment, even the leisure areas are built to facilitate socializing, from 12 meter long tables in lunchroom to the swings for those down moments to relax and finally the sofas, strictly sea view in order to find inspiration in the horizon line that forms one of the company's founding beliefs.

The project also includes a future gym for employees and a nursery, considering that the company is 50% female, a company garden and a exhibition space for young Sicilian artists. All signs denoting a strong investment on corporate culture and Sicily in general, as a place to come back to do business and attract talent from around the world.

DESIGN DATA

Location Isola delle Femmine (PA) Italy
Site area 4.000 m²
Costruction period 2015
Tasks assigned and carried out interior design
Amount of work € 817.595,68
Type Office

TECHNICAL DATA

Squar-e Architettura (Francesco Briguglia, Giuseppe Di Prima Architetti) + Francesco Librizzi studio

CREDITS

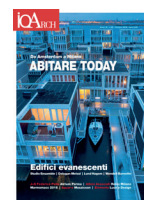
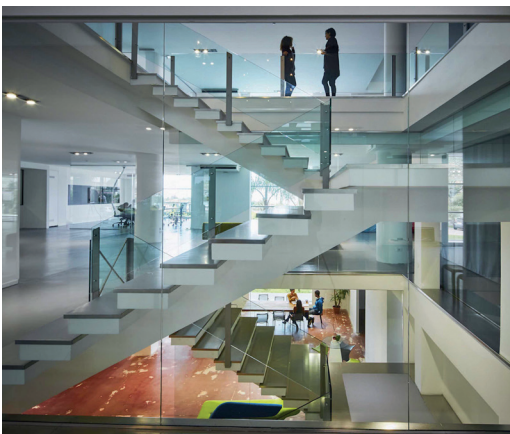



AMATO LUXURY LIVING: FURNITURE SHOWROOM

The company Amato Ceramiche s.r.l., needs to enlarge the current headquarters of the company and create a new image of the company itself. The project involves the demolition of the old building in favor of the creation of a new headquarters. With two floors above ground intended for showrooms, and a third consisting of a basement floor, the new volume includes a screening system, a green roof and panels of vertical gardens that allow to improve the indoor climate comfort and increase the permeability of the area covered by the building. The building consists of a glazed box, wrapped in an outer skin. This volumetric configuration allows a continuous view for almost all the interior spaces and the possibility of being able to enjoy an ideal brightness at all hours of the day, allowing you to expand the exhibition and work spaces to the green space in front, in a spatial continuum. The metallic cladding of façade, generates a changing and dynamic surface; and the use of micro-perforated steel sheet for the creation of external filters, makes the single external block more appealing, generating a camouflage skin with the use of monochrome and two-tone dark shades. The internal environment (strictly minimalist in order to emphasize the value of the product always at the center of attention), completely openspace, is interrupted only by a series of boxes, hosting the vertical connections, which seem to float inside the space. The austere, regular and continuous lines of the new building are contrasted, in perfect balance, to the dynamic lines, broken and fluid that draw the green in front.

DESIGN DATA

Private client AMATO CERAMICHE s.r.l.

Type of service definitive planning for the purpose of obtaining the building permit.

Floor 2 terrace 663 sqm

Floor 1 384 sqm showroom, 218 sqm home

Floor 0 603 square meters showroom

Floor -1 spa 180 square meters, parking 422 square meters

Total amount € 5.200.000,00

Location: Palermo

Surface of the lot 2,646 square meters

Gross covered area 1.380 square meters

Design period 2016

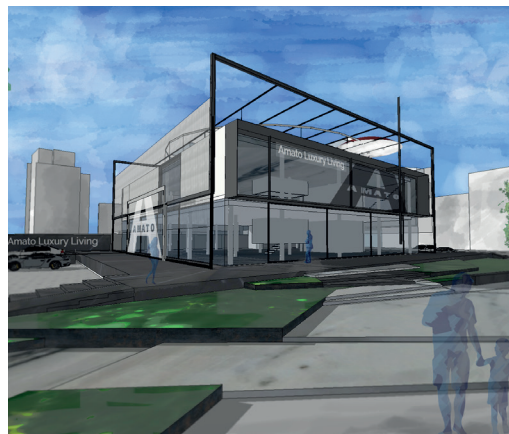
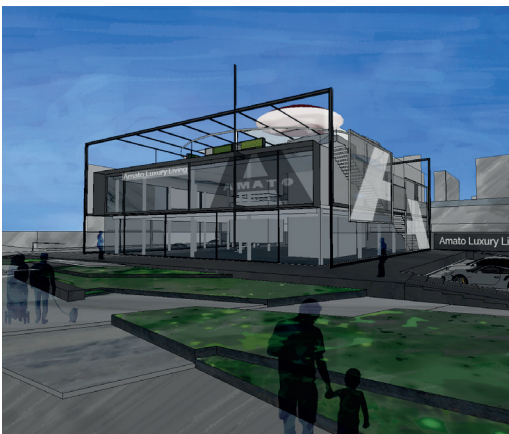

TECHNICAL DATA

Squar-e Architettura
(Francesco Briguglia, Giuseppe Di Prima Architetti), Laura D'Arcamo



RISERVA DELLE ACQUE: EXPANSION, REDEVELOPMENT AND INTEGRATION PROJECT

For the Hotel Terme delle Nazioni's receptivity, environmental redevelopment and landscape integration of the services are the main thematic of this enlargement project. Through a residence area immersed in a garden context and characterized by the flow of the spa waters, the possibility a new and unique perception of landscape Euganeo is offered.

Inside the "Water Reserve" a complex entertainment system for the comfort is located, in particular:

- Covered and uncovered thermal pools;
- SPA area;
- pavilion dedicated to fitness with a pool and a connected restaurant dedicated to Colli Euganei's eno-gastronomic excellence.

The thermal waters is the main protagonist outside the buildings and the long bathing canal (about 350 m) draws the territory. The canal leads through the thermal landscape, and like a large river route with its beaches, it naturally indicates the street for the guests' dedicated comfort route. The main buildings are three: club house with SPA area, fitness pavilion and restaurant.



DESIGN DATA

Location Montegrotto Terme (PD) Italy
Site area 24.000 m²
Project period 2015-2016
Tasks assigned and carried out Final project
Amount of work € 3.436.900,00
Type Spa, Bio-pool, club-house, fitness pavilion, thermal resort, thermal park

TECHNICAL DATA

Squar-e Architettura (Francesco Briguglia, Giuseppe Di Prima Architetti), Laura D'Arcamo



Building
trust
together.

Certificate

CISQ / RINA has issued an IQNET recognized certificate that the organization:

OWAC ENGINEERING COMPANY S.R.L.

VIA RESUTTANA, 360 90146 Palermo (PA) ITALIA

has implemented and maintains a/an

Quality Management System

for the following scope:

PROVISION OF SERVICES OF PROJECT MANAGEMENT. DESIGN IN THE CIVIL AND INDUSTRIAL FIELD WITH BUILDING INFORMATION MODELING METHODOLOGY APPLICATION (BIM). SUPERVISION OF WORKS. CHECK OF WORKS DESIGN FOR VALIDATION/APPROVAL IN ACCORDANCE WITH CURRENT LEGISLATION.

which fulfills the requirements of the following standard:

ISO 9001:2015

Issued on: **2023-02-07**

First Issued on: **2014-02-12**

Expires on: **2026-02-11**

All details about any legal entities, operative units and related activities included in this certificate are contained in CISQ/RINA original certificate no.: **30233/14/S**

Registration Number: **IT-93091**

Alex Stoichitoiu
President of IQNET

Mario Romersi
President of CISQ



This attestation is directly linked to the IQNET Member's original certificate and shall not be used as a stand-alone document.

IQNET Members*:

AENOR Spain **AFNOR Certification** France **APCER** Portugal **CCC** Cyprus **CISQ** Italy **CQC** China **CQM** China **CQS** Czech Republic
Cro Cert Croatia **DQS Holding GmbH** Germany **EAGLE Certification Group** USA **FCAV** Brazil **FONDONORMA** Venezuela **ICONTEC**
Colombia **ICS** Bosnia and Herzegovina **Inspecta Sertifointi Oy** Finland **INTECO** Costa Rica **IRAM** Argentina **JQA** Japan **KFQ** Korea
LSQA Uruguay **MIRTEC** Greece **MSZT** Hungary **Nemko AS** Norway **NSAI** Ireland **NYCE-SIGE** México **PCBC** Poland **Quality Austria**
Austria **SII** Israel **SIQ** Slovenia **SIRIM QAS International** Malaysia **SQS** Switzerland **SRAC** Romania **TSE** Türkiye **YUQS** Serbia

* The list of IQNET Members is valid at the time of issue of this certificate. Updated information is available under www.iqnet-certification.com



Building
trust
together.

Certificate

CISQ / RINA has issued an IQNET recognized certificate that the organization:

OWAC ENGINEERING COMPANY S.R.L.

VIA RESUTTANA, 360 90146 PALERMO (PA) ITALIA

has implemented and maintains a/an

Environmental Management System

for the following scope:

PROVISION OF SERVICES OF PROJECT MANAGEMENT. DESIGN IN THE CIVIL AND INDUSTRIAL FIELD WITH BUILDING INFORMATION MODELING METHODOLOGY APPLICATION (BIM). SUPERVISION OF WORKS. CHECK OF WORKS DESIGN FOR VALIDATION/APPROVAL IN ACCORDANCE WITH CURRENT LEGISLATION. PROVISION OF ENERGY SERVICES.

which fulfills the requirements of the following standard:

ISO 14001:2015

Issued on: **2023-05-24**

First Issued on: **2023-05-24**

Expires on: **2026-05-23**

All details about any legal entities, operative units and related activities included in this certificate are contained in CISQ/RINA original certificate no.: **EMS-9477/S**

Registration Number: **IT-146452**

Alex Stoichitoiu
President of IQNET

Mario Romersi
President of CISQ



This attestation is directly linked to the IQNET Member's original certificate and shall not be used as a stand-alone document.

IQNET Members*:

AENOR Spain **AFNOR Certification** France **APCER** Portugal **CCC** Cyprus **CISQ** Italy **CQC** China **CQM** China **CQS** Czech Republic
Cro Cert Croatia **DQS Holding GmbH** Germany **EAGLE Certification Group** USA **FCAV** Brazil **FONDONORMA** Venezuela **ICONTEC**
Colombia **ICS** Bosnia and Herzegovina **Inspecta Sertifointi Oy** Finland **INTECO** Costa Rica **IRAM** Argentina **JQA** Japan **KFQ** Korea
LSQA Uruguay **MIRTEC** Greece **MSZT** Hungary **Nemko AS** Norway **NSAI** Ireland **NYCE-SIGE** México **PCBC** Poland **Quality Austria**
Austria **SII** Israel **SIQ** Slovenia **SIRIM QAS International** Malaysia **SQS** Switzerland **SRAC** Romania **TSE** Türkiye **YUQS** Serbia

* The list of IQNET Members is valid at the time of issue of this certificate. Updated information is available under www.iqnet-certification.com



CISQ is a member of



The International Certification Network
www.iqnet-certification.com

CERTIFICATO N.

OHS-4849

CERTIFICATE No.

Si certifica che il Sistema di Gestione della Sicurezza e della Salute sul luogo di lavoro di
It is hereby certified that the Occupational Health and Safety Management System of

OWAC ENGINEERING COMPANY S.R.L.

VIA RESULTANA, 360 90146 PALERMO (PA) ITALIA

nelle seguenti unità operative / *in the following operational units*

VIA RESULTANA, 360 90146 Palermo (PA) ITALIA E CANTIERI OPERATIVI

è conforme alla norma / *is in compliance with the standard*

ISO 45001:2018

per le seguenti attività / *for the following activities*

EROGAZIONE DI SERVIZI DI PROJECT MANAGEMENT. PROGETTAZIONE IN AMBITO CIVILE E INDUSTRIALE CON APPLICAZIONE DI METODOLOGIA BUILDING INFORMATION MODELLING (BIM). DIREZIONE LAVORI. VERIFICHE SULLA PROGETTAZIONE DELLE OPERE AI FINI DELLA VALIDAZIONE/APPROVAZIONE, AI SENSI DELLA NORMATIVA VIGENTE. EROGAZIONE DI SERVIZI ENERGETICI.

IAF:34

PROVISION OF SERVICES OF PROJECT MANAGEMENT. DESIGN IN THE CIVIL AND INDUSTRIAL FIELD WITH BUILDING INFORMATION MODELING METHODOLOGY APPLICATION (BIM). SUPERVISION OF WORKS. CHECK OF WORKS DESIGN FOR VALIDATION/APPROVAL IN ACCORDANCE WITH CURRENT LEGISLATION. PROVISION OF ENERGY SERVICES.

La validità del presente certificato è subordinata a sorveglianza periodica annuale / semestrale ed al riesame completo del sistema di gestione con periodicità triennale

The validity of this certificate is dependent on an annual / six monthly audit and on a complete review, every three years, of the management system

L'uso e la validità del presente certificato è soggetto al rispetto del documento RINA: Regolamento per la Certificazione dei Sistemi di Gestione della Sicurezza e Salute sul luogo di lavoro

The use and validity of this certificate are subject to compliance with the RINA document: Rules for the Certification of Occupational Health and Safety Management Systems

Prima emissione
First Issue

05.12.2022

Data scadenza
Expiry Date

04.12.2025

Data revisione
Revision date

05.12.2022

Maurizio Mazzapicchi

Catania & Palermo Management
System Certification, Head



SCR N° 003 F

Membro degli Accordi di Mutuo Riconoscimento EA, IAF e ILAC
Signatory of EA, IAF and ILAC Mutual Recognition Agreements

RINA Services S.p.A.
Via Corsica 12 - 16128 Genova Italy



www.cisq.com

CISQ è la Federazione Italiana di Organismi di Certificazione dei sistemi di gestione aziendale
CISQ is the Italian Federation of management system Certification Bodies



CERTIFICATO N.

SGBIM-01/23

CERTIFICATE No.

Per informazioni sulla validità del
certificato, visitare il sito
www.rina.org

For information concerning validity of
the certificate, you can visit the site
www.rina.org

SI CERTIFICA CHE IL SISTEMI DI GESTIONE BIM
IT IS HEREBY CERTIFIED THAT THE BIM MANAGEMENT SYSTEMS OF

OWAC ENGINEERING COMPANY S.R.L.

VIA RESUTTANA, 360 90146 Palermo (PA) ITALIA
NELLE SEGUENTI UNITÀ OPERATIVE / *IN THE FOLLOWING OPERATIONAL UNITS*

VIA RESUTTANA, 360 90146 Palermo (PA) ITALIA

E' CONFORME ALLA PRASSI DI RIFERIMENTO / *IS IN COMPLIANCE THE REFERENCE PROCEDURE*

UNI/PdR 74:2019

PER LE SEGUENTI ATTIVITÀ / *FOR THE FOLLOWING ACTIVITIES*

IAF 34

PROGETTAZIONE ARCHITETTONICA, STRUTTURALE ED IMPIANTISTICA

ARCHITECTURAL, STRUCTURAL AND PLANT DESIGN

La validità del presente certificato è subordinata a sorveglianza periodica annuale / semestrale ed al riesame completo del sistema di gestione con periodicità triennale
The validity of this certificate is dependent on an annual/six monthly audit and on a complete review, every three years, of the management system

L'uso e la validità del presente certificato è soggetto al rispetto del regolamento RINA applicabile
The use and validity of this certificate are subject to compliance with the requirements of the applicable RINA Rules

Prima emissione
First Issue 12/05/2023

Data scadenza
Expiry Date 11/05/2026

Data revisione
Revision date 12/05/2023

Maurizio Mazzapicchi

Catania & Palermo Management
System Certification, Head

RINA Services S.p.A.
Via Corsica 12 – 16128 Genova Italy



SGQ N° 002 A

Membro degli Accordi di Mutuo
Riconoscimento EA, IAF e ILAC
*Signatory of EA, IAF and ILAC
Mutual Recognition Agreements*



ICMQ

CISQ is a member of



*IQNet, the association of the world's first class certification bodies, is the largest provider of management System Certification in the world.
IQNet is composed of more than 30 bodies and counts over 150 subsidiaries all over the globe.*

CERTIFICATO CERTIFICATE 21042BIM

SI CERTIFICA CHE IL SISTEMA DI GESTIONE DI
WE HEREBY CERTIFY THAT MANAGEMENT SYSTEM OPERATED BY

OWAC ENGINEERING COMPANY S.r.l.

Via Resuttana, 360 - 90146 Palermo PA

UNITA' OPERATIVE CERTIFICATE
OPERATIONAL CERTIFIED UNITS

Via Resuttana, 360 - 90146 Palermo PA

E' CONFORME ALLA PRASSI DI RIFERIMENTO
IS IN COMPLIANCE WITH REFERENCE PROCEDURE

UNI/PdR 74:2019

PER I SEGUENTI TIPI DI PRODOTTI, PROCESSI E SERVIZI
COVERING THE FOLLOWING KIND OF PRODUCTS, PROCESSES AND SERVICES

EA: 34

progettazione architettonica, strutturale e impiantistica

architectural, structural and plant design

L'uso e la validità del presente certificato sono soggetti al rispetto delle Condizioni Generali di Contratto per la certificazione di sistemi di gestione
Use and validity of this certificate subject to General Agreement Conditions for certification of management systems

PRIMA EMISSIONE
FIRST ISSUE
02/08/2021

EMISSIONE CORRENTE
CURRENT ISSUE
02/08/2021

SCADENZA
EXPIRY
31/07/2024



Il Presidente e Direttore Generale
Ing. Lorenzo Orsenigo



SGQ N° 011A
Membro degli Accordi di Mutuo Riconoscimento EA, IAF e ILAC
Signatory of EA, IAF and ILAC Mutual Recognition Agreements



www.cisq.com

CISQ è la Federazione Italiana di Organismi di Certificazione dei sistemi di gestione aziendale.
CISQ is the Italian Federation of management system Certification Bodies.

ICMQ S.p.A. – Via De Castilia, 10 – 20124 MILANO - www.icmq.org - icmq@icmq.org

IMPORTO LAVORI ULTIMI 10 ANNI

ID OPERE	IDENTIFICAZIONE DELLE OPERE	TOTALE	SERVIZIO 1	SERVIZIO 2	TOT. SERVIZI DI PUNTA
E01	Edifici rurali per l'attività agricola con corredi tecnici di tipo semplice (quali tettoie, depositi e ricoveri) - Edifici industriali o artigianali di importanza costruttiva corrente con corredi tecnici di base.	4.953.479,77 €	3.158.609,21 €	1.794.870,56 €	4.953.479,77
E02	Edifici rurali per l'attività agricola con corredi tecnici di tipo complesso - Edifici industriali o artigianali con organizzazione e corredi tecnici di tipo complesso	33.461.347,75 €	9.232.486,11 €	6.137.933,95 €	15.370.420,06
E10	Poliambulatori, Ospedali, Istituti di ricerca, Centri di riabilitazione, Poli scolastici, Università, Accademie, Istituti di ricerca universitaria	9.325.282,08 €	9.325.282,08 €	-	9.325.282,08
E20	Interventi di manutenzione straordinaria, ristrutturazione, riqualificazione, su edifici e manufatti esistenti	4.285.000,00 €	4.285.000,00 €	-	4.285.000,00
S03	Strutture o parti di strutture in cemento armato - Verifiche strutturali relative - Ponteggi, centinate e strutture provvisorie di durata superiore a due anni.	20.457.060,87 €	8.987.487,70 €	4.579.692,25 €	13.567.179,95
S04	Strutture o parti di strutture complesse in cemento armato.	3.825.526,50 €	3.013.985,50 €	811.541,00 €	3.825.526,50
S06	Opere strutturali di notevole importanza costruttiva e richiedenti calcolazioni particolari - Verifiche strutturali relative - Strutture con metodologie normative che richiedono modellazione particolare: edifici alti con necessità di valutazioni di secondo ordine.	1.129.640,00 €	724.640,00 €	405.000,00 €	1.129.640,00
IA.01	Impianti per l'approvvigionamento, la preparazione e la distribuzione di acqua nell'interno di edifici o per scopi industriali - Impianti sanitari - Impianti di fognatura domestica od industriale ed opere relative al trattamento delle acque di rifiuto - Reti di distribuzione di combustibili liquidi o gassosi - Impianti per la distribuzione dell'aria compressa del vuoto e di gas medicali - Impianti e reti antincendio	5.817.753,33 €	2.431.879,47 €	1.281.861,30 €	3.713.740,77
IA.02	Impianti di riscaldamento - Impianto di raffrescamento, climatizzazione, trattamento dell'aria - Impianti meccanici di distribuzione fluidi - Impianto solare termico	31.092.520,43 €	11.680.047,11 €	4.461.341,52 €	16.141.388,63
IA.03	Impianti elettrici in genere, impianti di illuminazione, telefonici, di rivelazione incendi, fotovoltaici, a corredo di edifici e costruzioni di importanza corrente - singole apparecchiature per laboratori e impianti pilota di tipo semplice	5.516.307,27 €	1.708.612,40 €	1.695.815,10 €	3.404.427,50
IA.04	Impianti elettrici in genere, impianti di illuminazione, telefonici, di sicurezza, di rivelazione incendi, fotovoltaici, a corredo di edifici e costruzioni complessi - cablaggi strutturati - impianti in fibra ottica - singole apparecchiature per laboratori e impianti pilota di tipo complesso	23.286.923,22 €	5.235.198,87 €	5.040.000,00 €	10.275.198,87
IB.04	Depositi e discariche senza trattamento dei rifiuti.	111.416.762,94 €	76.158.381,41 €	26.219.396,96 €	102.377.778,37
IB.06	Impianti della industria chimica inorganica - Impianti della preparazione e distillazione dei combustibili - Impianti siderurgici - Officine meccaniche e laboratori - Cantieri navali - Fabbriche di cemento, calce, laterizi, vetriere e ceramiche - Impianti per le industrie della fermentazione, chimico-alimentari e tintorie - Impianti termovalorizzatori e impianti di trattamento dei rifiuti - Impianti della industria chimica organica - Impianti della piccola industria chimica speciale - Impianti di metallurgia (esclusi quelli relativi al ferro) - Impianti per la preparazione ed il trattamento dei minerali per la sistemazione e coltivazione delle cave e miniere	146.507.487,25 €	38.489.449,41 €	32.801.345,32 €	71.290.794,73
IB.07	Gli impianti precedentemente esposti quando siano di complessità particolarmente rilevante o comportanti rischi e problematiche ambientali molto rilevanti	189.666.813,98 €	36.825.466,06 €	33.890.183,94 €	70.715.650,00
IB.08	Impianti di linee e reti per trasmissioni e distribuzione di energia elettrica, telegrafia, telefonia.	4.221.659,12 €	3.390.000,00 €	357.882,00 €	3.747.882,00
IB.10	Impianti termoelettrici - Impianti dell'elettrochimica - Impianti della elettrometallurgia - Laboratori con ridotte problematiche tecniche	6.183.885,91 €	1.665.196,00 €	1.632.763,12 €	3.297.959,12
IB.11	Campi fotovoltaici - Parchi eolici	1.000.368,00 €	1.000.368,00 €	0,00 €	0,00
IB.12	Micro Centrali idroelettriche - Impianti termoelettrici - Impianti della elettrometallurgia di tipo complesso	17.966.626,98 €	4.928.863,65 €	4.921.871,52 €	9.850.735,17
V.02	Strade, linee tramviarie, ferrovie, strade ferrate, di tipo ordinario, escluse le opere d'arte da compensarsi a parte - Piste ciclabili	7.568.507,07 €	1.585.000,00 €	1.470.008,50 €	3.055.008,50
V.03	Strade, linee tramviarie, ferrovie, strade ferrate, con particolari difficoltà di studio, escluse le opere d'arte e le stazioni, da compensarsi a parte - Impianti teleferici e funicolari - Piste aeroportuali e simili.	6.391.793,96 €	4.519.492,29 €	1.872.301,67 €	6.391.793,96
D.02	Bonifiche ed irrigazioni a deflusso naturale, sistemazione di corsi d'acqua e di bacini montani	2.470.067,71 €	1.282.306,04 €	1.187.761,67 €	2.470.067,71
D.04	Impianti per provvista, condotta, distribuzione d'acqua, improntate a grande semplicità - Fognature urbane improntate a grande semplicità - Condotte subacquee in genere, metanodotti e gasdotti, di tipo ordinario	14.577.069,45 €	8.577.825,51 €	1.705.129,00 €	10.282.954,51
D.05	Impianti per provvista, condotta, distribuzione d'acqua - Fognature urbane - Condotte subacquee in genere, metanodotti e gasdotti, con problemi tecnici di tipo speciale.	14.531.617,49 €	6.546.519,36 €	5.430.098,13 €	11.976.617,49
P.01	Opere relative alla sistemazione di ecosistemi naturali o naturalizzati, alle aree naturali protette ed alle aree a rilevanza faunistica. Opere relative al restauro paesaggistico di territori compromessi ed agli interventi su elementi strutturali del paesaggio. Opere di configurazione di assetto paesaggistico.	6.608.038,43 €	5.101.541,00 €	1.506.497,43 €	6.608.038,43
P.03	Opere di riqualificazione e risanamento di ambiti naturali, rurali e forestali o urbani finalizzati al ripristino delle condizioni originarie, al riassetto delle componenti biotiche ed abiotiche.	73.184.478,91 €	20.219.887,83 €	17.829.318,10 €	38.049.205,93
T.02	Reti locali e geografiche, cablaggi strutturati, impianti in fibra ottica, Impianti di videosorveglianza, controllo accessi, identificazione targhe di veicoli ecc Sistemi wireless, reti wifi, ponti radio.	939.785,00 €	564.285,00 €	375.500,00 €	939.785,00
T.03	Elettronica Industriale Sistemi a controllo numerico, Sistemi di automazione, Robotica	1.162.258,00 €	658.258,00 €	504.000,00 €	1.162.258,00
TOTALI		747.548.061,43 €	271.296.068,01 €	157.912.112,04 €	428.207.812,05



HEADQUARTERS

ITALIA (PALERMO)

Via Resuttana, 360 - 90146

INTERNATIONAL DESK

CINA (SHANGHAI)

Yunchou Bldg, 1239 Siping
Road, 200092 Shanghai,
Repubblica Popolare Cinese

COMMERCIAL DESK

UAE (DUBAI)

c/o Sharaf Future Trading
L.L.C P.O.
Box: 36801, Office No. 1,
Al Hilal Building, Sheikh
Rashid Road, Al Garhoud

PH: 0039 091 303243

EMAIL: owac@owac.it

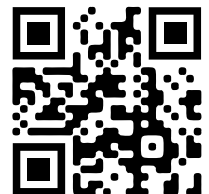

www.owac.eu